



Office building project

Submitted to Dr. Muhannad Haj Hussein

Alaa Alswad, Jehad Baniodeh,
Samer Banijaber.

A Sample Report Submitted in Partial Fulfillment of the
Requirements of graduation project Course (68590)

CONTENTS

List of figures	3
List of tables	6
Abstract.....	7
Chapter 1: Introduction.....	8
1.1. Over view	8
1.2. Research problem	8
1.3. Main Contribution.....	8
1.4. Report Organization	8
1.5. Methodology.....	8
Chapter 2: Architectural issues	9
2.1 Functionality:.....	9
2.2 Spaces:.....	10
2.2.1 Standards for spaces:	10
2.2.1.1 Office spaces	10
2.2.1.2 Meeting and conferences rooms:	13
2.2.1.3 Corridors and circulation:	15
2.2.1.4 W.C's (water closet –toilet-):	15
2.2.1.5 Small cafeteria - restaurant:	16
2.3 Computers and network spaces.....	19
2.4 Parking's	19
2.5 Stair case	21
2.5.1 Standers of design the stairs.....	22
2.6 Envelop.....	23
2.7 Entrance	23
Chapter 3: Structural issues	24
3.1 What Is Structure?.....	24
3.2 Foundation	24
3.3 Structure.....	28
3.4 Structural stability and efficiency.....	32
3.5 Walls.....	34
3.6 Roofs.....	34
Chapter 4: Mechanical issues	39
4.1 Heating, ventilation, and air conditioning	39
4.2 Elevators.....	42
4.3 Drainage system:	46

4.3.1 Sanitation of gray water and black water:	47
4.3.2 Vents	47
Chapter 5: Lighting	49
5.1 Windows.....	49
5.2 Clerestory window	49
5.3 Indoor artificial lighting	50
5.3.1 Fixture:	50
5.3.2 Standards level of illumination	51
Chapter 6: Case study	52
6.1 Shanghai Tower	52
6.1.1 Environmental side view	56
6.2 Menara mesiniaga:	57
6.2.1 Environmental design strategies:.....	58
6.2.2 Function and use	58
6.2.3 Technical data	59
6.2.4 Site and climate:	59
6.2.5 Main ideas and concepts for the MENARA MESINIAGA:	60
6.2.6 Shading devices:.....	61
6.2.7 Garden terraces:	63
6.2.8 Structural aspects	65
Chapter 7: Project program and site analysis.....	66
7.1 Project program	66
7.2 Site analysis	68
7.2.1 Location.....	68
7.2.2 Climate in Ramallah	69
7.2.3 Project Site	72
Bibliography.....	75

LIST OF FIGURES

Figure 1: bubble diagram for "office" building	9
Figure 2: work station standers.....	11
Figure 3 : deferent types of work stations (Neufert third edition)	12
Figure 4: different types of closed work stations.....	13
Figure 5: meeting room with 4 persons	14
Figure 6: meeting room with 5 persons	14
Figure 7: meeting room with 8 to 12 persons	14
Figure 8: corridor design (Neufert third edition)	15
Figure 9: different units that used on the bathrooms (Neufert third edition)	15
Figure 10: distribution of the bathrooms unit based on the functional relationship (Neufert third edition)	16
Figure 11: spaces for tables and chairs in the restaurants (Neufert third edition).....	16
Figure 12: side view of spaces for tables and chairs in the restaurants (Neufert third edition)	16
Figure 13: different types of tables with its diminutions (Neufert third edition).....	17
Figure 14: distribution of the furniture	17
Figure 15: traditional restaurants with 110 set.....	18
Figure 16: restaurant seating 124 with self-service carving table (Neufert third edition).....	18
Figure 17: standers car size (Neufert third edition) (JOSEF DE CHIARA n.d.).....	19
Figure 18: parking standers. (Neufert third edition)	20
Figure 19 :standard design for disable people	20
Figure 20: shape of stairs.....	21
Figure 21: stair recommended design. (JOSEF DE CHIARA n.d.).....	22
Figure 22: stair recommended design (Neufert third edition).....	22
Figure 23: stair recommended design (Neufert third edition).....	23
Figure 24: building envelop.....	23
Figure 25: modeling of the structure.....	24
Figure 26: single footing.....	25
Figure 27: the construction of footing	26
Figure 28: top view of single footing tied and spiral	26
Figure 29: combined footing top view.....	27
Figure 30: raft foundation top view	27
Figure 31: top view for mat foundation	28
Figure 32: pile foundation	28
Figure 33: masonry wall construction	29
Figure 34: concrete structure	30
Figure 35: steel construction.....	31
Figure 36: types of steel beams	31
Figure 37: high rise stable concrete building.....	32

Figure 38: Interior structures (strategies of architectural design and analysis 2007).....	33
Figure 39: Exterior structures (strategies of architectural design and analysis 2007).....	34
Figure 40: Roof components	35
Figure 41: roof level and slope	35
Figure 42: Roof types according to their forms	36
Figure 43: Brick masonry structure	36
Figure 44: Stone masonry structure	37
Figure 45: Timber frame structures	37
Figure 46: Reinforcement concrete frame	38
Figure 47: Steel frame	38
Figure 48: cross ventilation (Walter T. Grondzik 2010).....	39
Figure 49: stack ventilation (Walter T. Grondzik 2010).....	40
Figure 50: psychometrics chart (Walter T. Grondzik 2010).....	41
Figure 51: elevator distribution and location relationship	45
Figure 52: elevator distribution and location relationship	45
Figure 53: plumbing fixture.....	46
Figure 54: fitting used in the drainage system	46
Figure 55: Sewer gas relief through vents. Gases pressurized by hydraulic action or by expansion due to putrefaction have an escape, <i>the</i> lower floor shows circuit vents, permitted by some codes, where one vent serves the entire branch.	48
Figure 56: day light preview	49
Figure 57: Clerestory window	50
Figure 58: some type of fixture	51
Figure 59: shanghai tower	52
Figure 60: core profile and lateral system of shanghai tower	53
Figure 61: office zone.....	54
Figure 62: tower divided zones.....	55
Figure 63: curtain wall system.....	57
Figure 64: Axonometrics: (Left to Right) Built form; Planting & sky gardens; Solar orientation; Shading devices	58
Figure 65: site of the project.....	59
Figure 66: function and use for first and ninth floor.....	60
Figure 67: function and use for mid and fourth and eighth floor.....	60
Figure 68: function and use for second, seventh and tenth floor	61
Figure 69: shading devices	61
Figure 70: garden and sun shaders.....	62
Figure 71: techniques for environmental design.....	62
Figure 72: the shading effect due to garden terraces	63
Figure 73: garden spiral, sun shaders and sun screens.....	63

Figure 74: section shows land scape	64
Figure 75: Outdoor employee swimming pool	65
Figure 76: average solar radiation (The Palestinian Central Bureau Climate in the west bank 2013).....	69
Figure 77: The maximum, average, and minimum temperatures (The Palestinian Central Bureau Climate in the west bank 2013).....	69
Figure 78: avg. relative humidity (The Palestinian Central Bureau Climate in the west bank 2013).....	70
Figure 79: The average rain fall (The Palestinian Central Bureau Climate in the west bank 2013).....	70
Figure 80: The average wind speed (The Palestinian Central Bureau Climate in the west bank 2013)	71
Figure 81: the project site relative to Ramallah city center	72
Figure 82: site plan - Aerial photograph.....	73
Figure 83: site plan and dimension	74

LIST OF TABLES

Table 1: recommended workstation sizes for various job functions	11
Table 2: meeting and conference room standard area.....	13
Table 3: Minimum Percent Handling Capacities (PHC) (Walter T. Grondzik 2010).....	43
Table 4: Car Passenger Capacity (p) (Walter T. Grondzik 2010).....	43
Table 5: Recommended Elevator Intervals and Related Lobby Waiting Time. (Walter T. Grondzik 2010).....	44
Table 6: Population of Typical Buildings for Estimating Elevator and Escalator Requirements. (Walter T. Grondzik 2010).....	44
Table 7 recommended illumination in lux for offices.....	51
Table 8: estimated area for administration	66
Table 9: estimated area for Human Resources Department.....	66
Table 10: estimated area for Legal Department and strategy	66
Table 11: estimated area for Finance department	67
Table 12: estimated area for Sales	67
Table 13: estimated area for marketing	67
Table 14: estimated area for information technology	67
Table 15: estimated area for technical	68
Table 16: estimated area for other public spaces	68

ABSTRACT

The office building is a type of building that used as a business center, which contain many spaces that called offices. The main reason of our thinking is that the functionality of the office buildings that providing services in our country doesn't offers the aims for which it where designed.

What we are going to do is to design an office building for Alwatania mobile company. Our objectives in this research is to choose the better architectural, structural, and mechanical requirements that achieve the environmental targets for offices design.

The methodology adopted for this research based principally on literature review, case analyses study, and environmental field measurements.

CHAPTER 1: INTRODUCTION

1.1.OVER VIEW

Office buildings in particular are type refer to variety including: meeting spaces integrated into the office environment, reception, office support spaces such as workrooms, storage rooms, and telephone and communications equipment rooms. The office space type is typically a flexible environment that integrates technology, comfort and safety, and energy efficiency to provide a productive, cost effective, and aesthetically pleasing working environment. Every part of building is subjected to the effects of outside forces, gravity, wind, earthquakes and , and temperature changes, all of these forces epically wind load because we have tower building must be taken into consideration. An office building must be able to accommodate the specific spaces and equipment needs of the tenant. Special attention should be made to the selection of interior finishes and art installations, particularly in enter spaces, conference rooms and other areas with public access.

1.2.RESEARCH PROBLEM

The main purpose of this project focuses on how to design an energy-efficient office building in Ramallah. The building is proposed to be the headquarter for Al Wataniya communication and mobile company

1.3.MAIN CONTRIBUTION

This research project contributes to understand the office building towers that are usually designed in a wrong way in our country, thus we are trying to solve these problems as much as possible.

1.4.REPORT ORGANIZATION

Our project is organized as follows:

Chapter 2 discuss architectural issue, chapter 3discuss Structural issues, chapter 4 Mechanical issues, chapter 5 discuss lighting issue, and chapter 6 discuss the project program and site analysis.

1.5.METHODOLOGY

The methodology adopted for this research based principally on literature review, we search in the literature review for a standard design of office building for architectural, structural, lighting, and mechanical. The methodology also take into consideration some case studies like Shanghai tower, Menara Mesiniaga. In addition of case studies we do the environmental field measurements by visiting the site and collecting data.

Finally we do the site analyses for sunlight, relative humidity, rainfall, and wind speed in order to take the effect of these variables in consideration in the second semester.

The way in which the office designed for architecture is that how the space used. In our case the whole building will be used for a Al-Wataniya mobile communication company

2.1 Functionality:

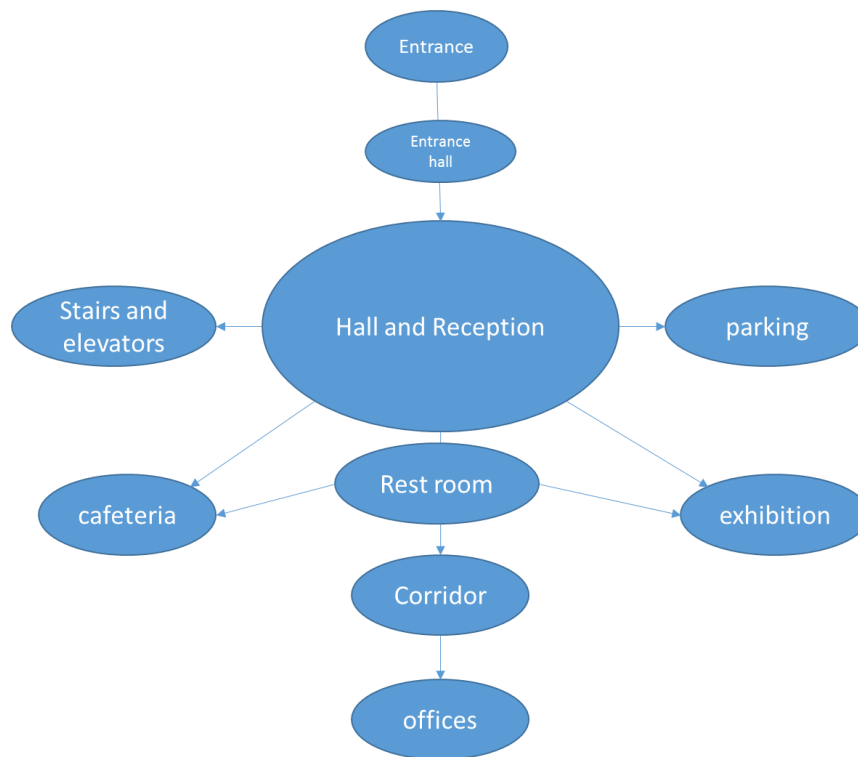

Figure 1: bubble diagram for "office" building

In office building functionality have to be a very important issue ,since it provides a comfortable range for employees, visitors and managers. By easy to use for communication skills.

The color of floor and the material which will be used, imparts a kind of psychological comfort.

We have to think about everything we want to put in our office how much space it will take where our equipment’s is going to go, what is going to power up everything, and where the storage space will be.

“Brilliant colors, innovative designs and surfaces in combination with the functionality of the familiar Nora rubber floor coverings. These were the reasons to use Nora again in our new own office rooms Office 2015”. (Jones and David 1998)

The modern working world with its teamwork and requires new lighting solutions. Designing a lighting system for optimum functionality.

Offices of managers are sensitive places , usually it found in independently offices to achieves privacy ,this rooms must to be enough areas and good decoration in order to respect it functionality ,moreover it have to be an secretary office to resave employees and visitors .

We are mention that the receptions places are far away from office manager it means that the office manager and secretary office which related to office manager are in independently entrance ,one entrance no more .

2.2 SPACES:

The office unit must have an enough space for its use, and depend on the furniture and equipment contain. Thus, the furniture, equipment, movement areas, and the people, will control the space areas. Also, we must take into consideration the flexibility of the spaces this principle fewer barriers to change, less distribution when change does occur, and lower costs in money and time can be accomplished by using open spaces and use flexible materials for construct portions.

The spaces should be allocated according to functional requirements, so that the location depend on the people position in the company. Departments should be empowered to plan their office space, this principle recognizes that, if office space is treated as an administrative resource and managers are given the opportunity to plan office space using simplified.

We must know that the office buildings also contain meeting rooms and conference rooms, W.C's units, corridor's, entrance, parking's, cafeteria, stare case, and special spaces for equipment which will take a special spaces that need a quiet and more comfortable resources from the hand of environmental point view this spaces also controlled by the equipment, furniture, people and movement areas.

2.2.1 STANDARDS FOR SPACES:

2.2.1.1 Office spaces

Office spaces as mentioned above are depend on its use, in general office spaces there is what we called work station which is a unit of furniture and equipment used

Table 1: recommended workstation sizes for various job functions

Space Type	Functional Assignment	Space Allocation	
		m ²	ft ²
Enclosed Type A	Frequent meetings with up to four others and/or requiring confidentiality, security, visual and acoustical privacy. Typical assignment for Deputy Minister or equivalent.	22.5	240
Enclosed Type B	Frequent meetings with up to two others and/or requiring confidentiality, security, visual and acoustical privacy. Typical assignment for Assistant Deputy Minister, Director, senior position in charge of a regional or district office or equivalent.	13.9	150
Enclosed Type C	Frequent meetings with up to two others and/or requiring confidentiality, security, visual and acoustical privacy. Typical assignment for position involved with counseling, human resources management or other sensitive situations requiring ongoing visual and acoustical privacy.	9.3	100
Open Type D	Concentrated multi-source paperwork: compiling information, reading, writing, analyzing, calculating and referencing multiple sources of material; allows for manual and automated drafting functions. Typical assignment for managerial, professional or technical staff.	9.3	100
Open Type E	Multi-task paper intensive work: telephone work, keyboarding, filing, sorting documents, handling mail, editing, operating equipment, scheduling, receiving visitors. Typical assignment for secretary and administrative support staff.	6.5	70
Open Type F	Specific, task-oriented work, focusing on data input into electronic media. Typical assignment for clerical and data-entry staff.	4.5	50

The work stations most frequently used is a desk and it accessories like the figure 2 and figure 3.

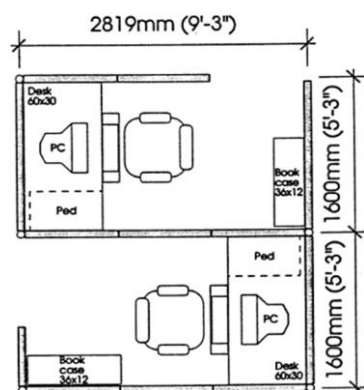

Figure 2: work station standers

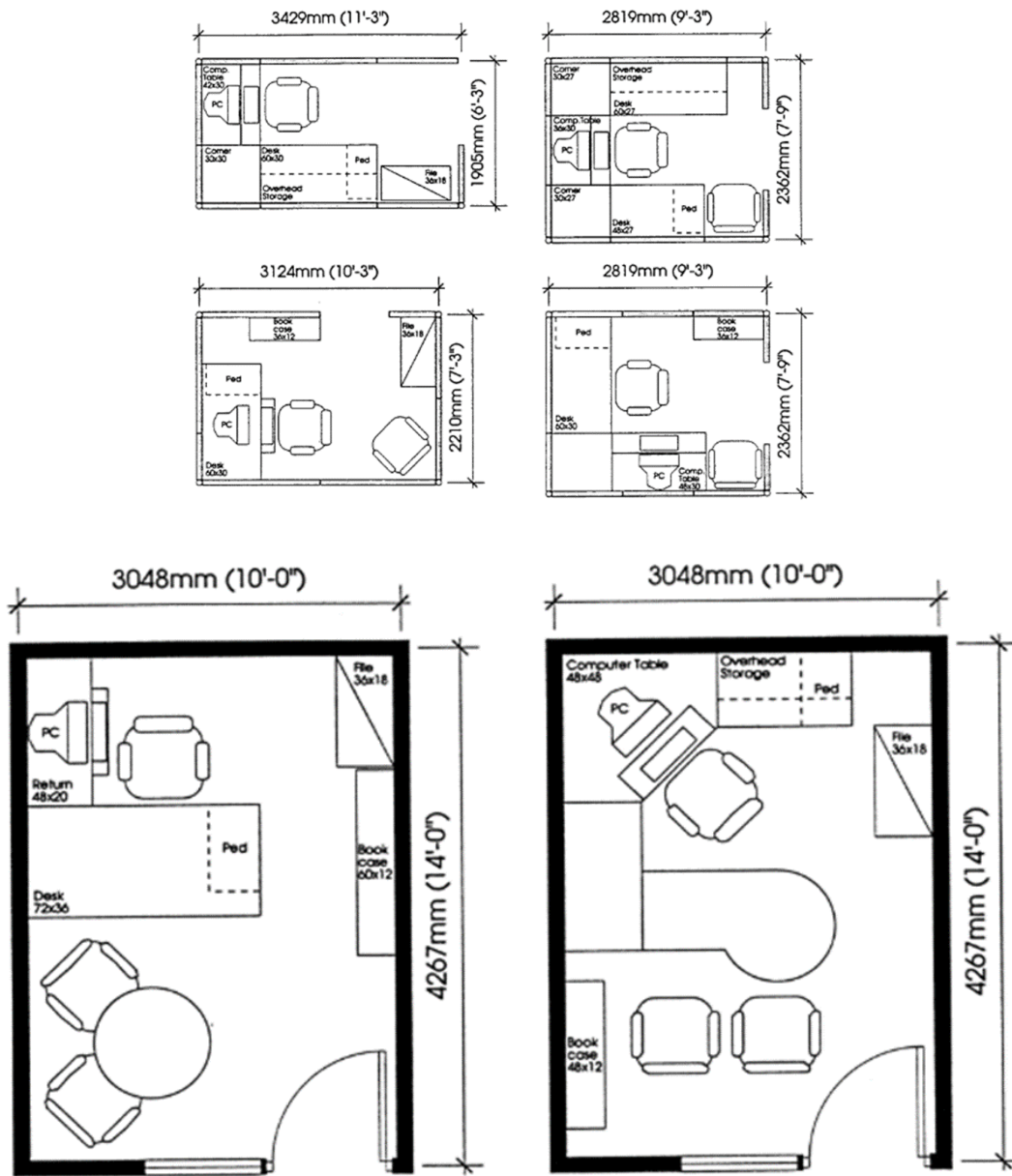

Figure 3 : different types of work stations (Neufert 2012)

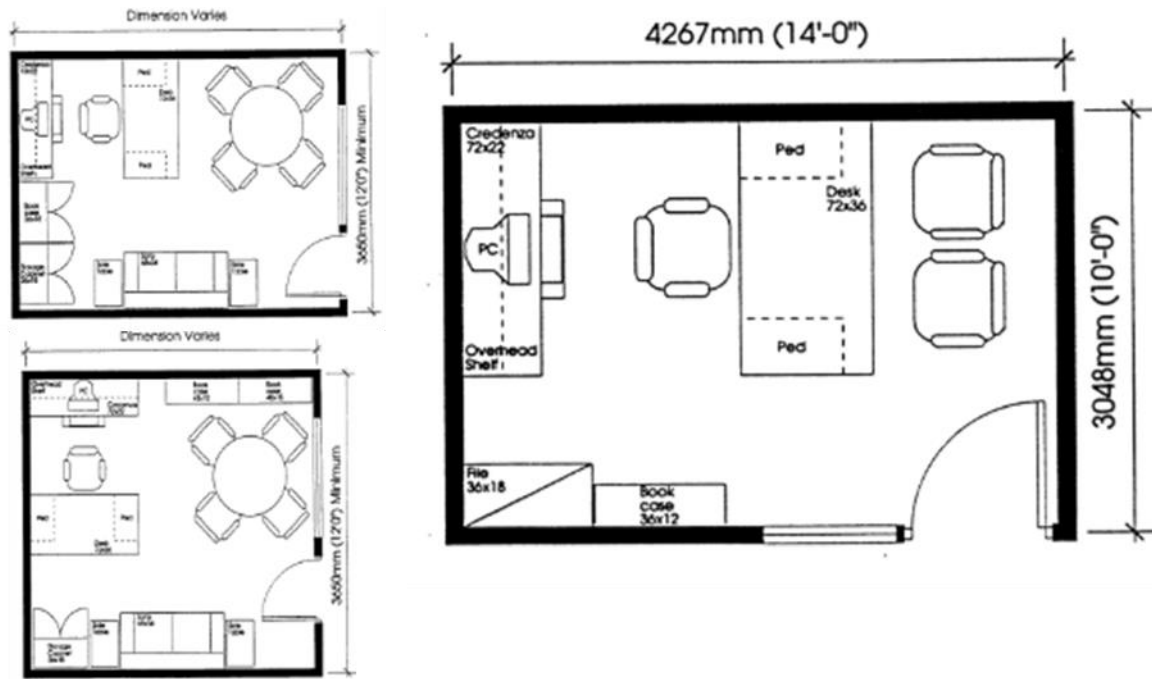

Figure 4: different types of closed work stations

2.2.1.2 Meeting and conferences rooms:

The meeting rooms as a standers of functionality, the table shows the surface area of such space in function of its capacity – occupants-:

Table 2: meeting and conference room standard area

Number of people	Area
From 4 to 5 people	11.15 m ²
From 5 to 7 people	13.9 m ²
Meeting of 12 people	22.3 m ²

Figure 5, figure 6 and figure 7 below represent the areas and distribution of the furniture on the meeting rooms.

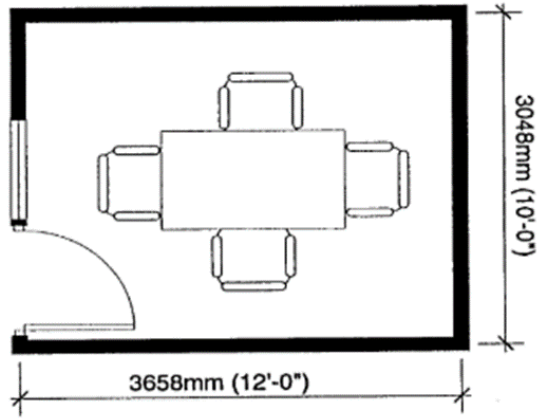

Figure 5: meeting room with 4 persons

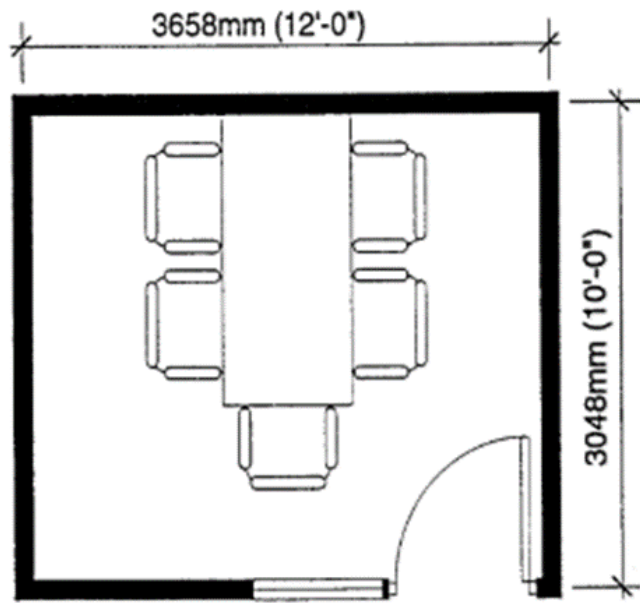

Figure 6: meeting room with 5 persons

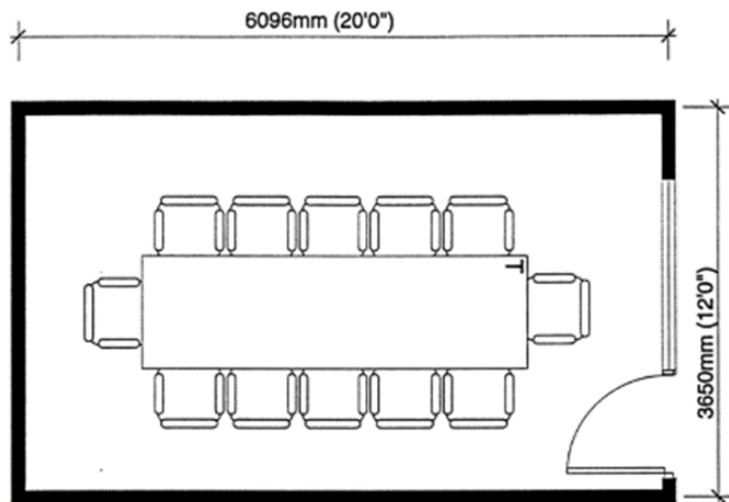

Figure 7: meeting room with 8 to 12 persons

2.2.1.3 Corridors and circulation:

The corridors in the office building must be widely for movement easily and also has enough space for door opening and assuming 2 people passing through like figure 8 below

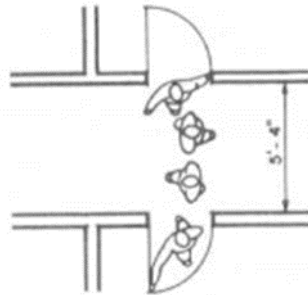

Figure 8: corridor design (Neufert and Ernst 2012)

Figure 8 represent the standards dimension of corridor thus, the minimum width of the corridor is 1.52 m to give the minimum comfort.

2.2.1.4 W.C's (water closet –toilet-):

The W.C's is a very important unit that is indispensable for buildings and it requires a special spaces for it. The furniture and equipment used in the toilet is wall-mounted bidet, flush bowel, wall-mounted deep flush ...etc.

In the case of office building the usage of the bathroom is limited not like residential usage, but culturally two units of W.C (men and women) must be designed in such buildings.

Figure 9 below represent the standards dimensions for W.C's spaces (Neufert 2012)

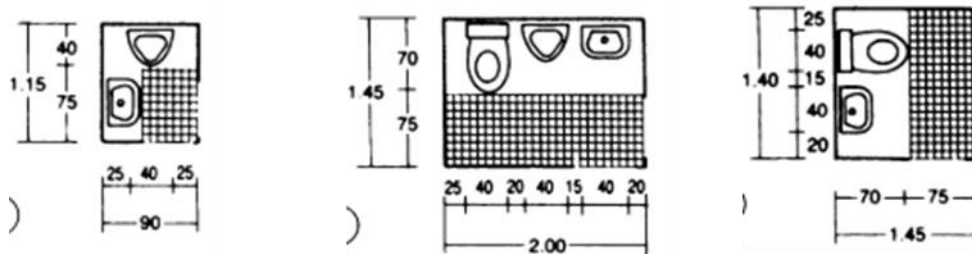

Figure 9: different units that used on the bathrooms (Neufert and Ernst 2012)

The distribution of the furniture units depends on the Functional relationship between it might be similar to figure 10 below

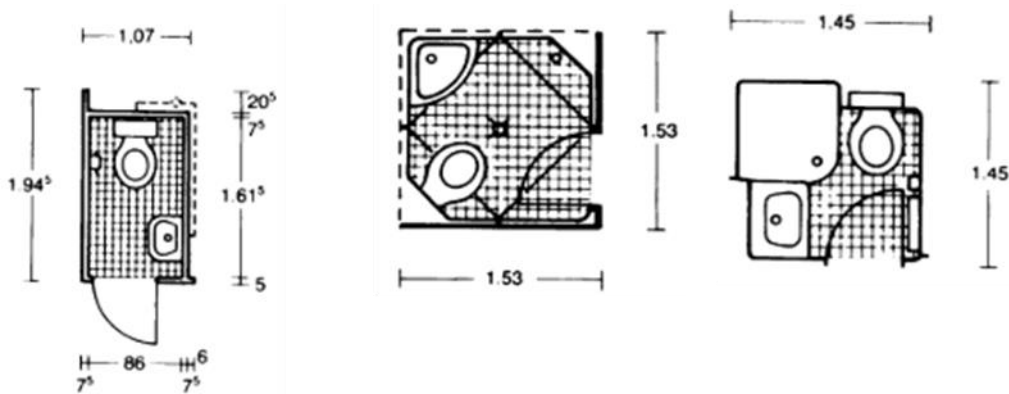

Figure 10: distribution of the bathrooms unit based on the functional relationship (Neufert and Ernst 2012)

From environmental point view the natural ventilation for the W.C's is required.

2.2.1.5 Small cafeteria - restaurant:

The cafeteria in the office building is a small restaurant for the employees and it might be used by the reviewers on there waiting time, so, it will be for small jobs.

The cafeteria must have a position on the ground floor closer to the reviewers and employees and it contains an enough space for tables and staff work place.

The standard dimensions for the person to be eat comfortably is 60 cm wide and 40 cm deep. With the additional spaces for dishes and neighborhood the spaces that figure 11, figure12, and figure 13 represent below will be sufficient.

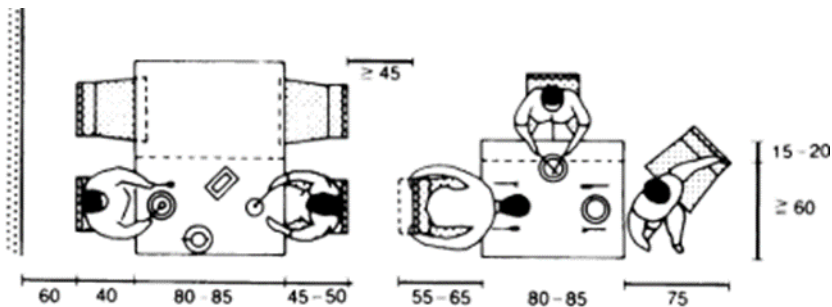

Figure 11: spaces for tables and chairs in the restaurants (Neufert and Ernst 2012)



Figure 12: side view of spaces for tables and chairs in the restaurants (Neufert and Ernst 2012)

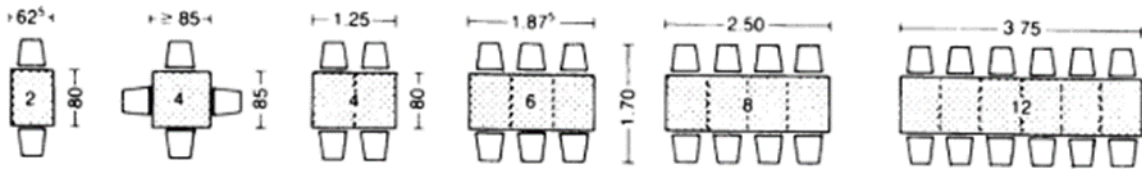

Figure 13: different types of tables with its diminutions (Neufert 2012)

The distribution of the furniture in the cafeteria spaces might take different forms, figure 14, 15, 16 shows some examples of these distribution:

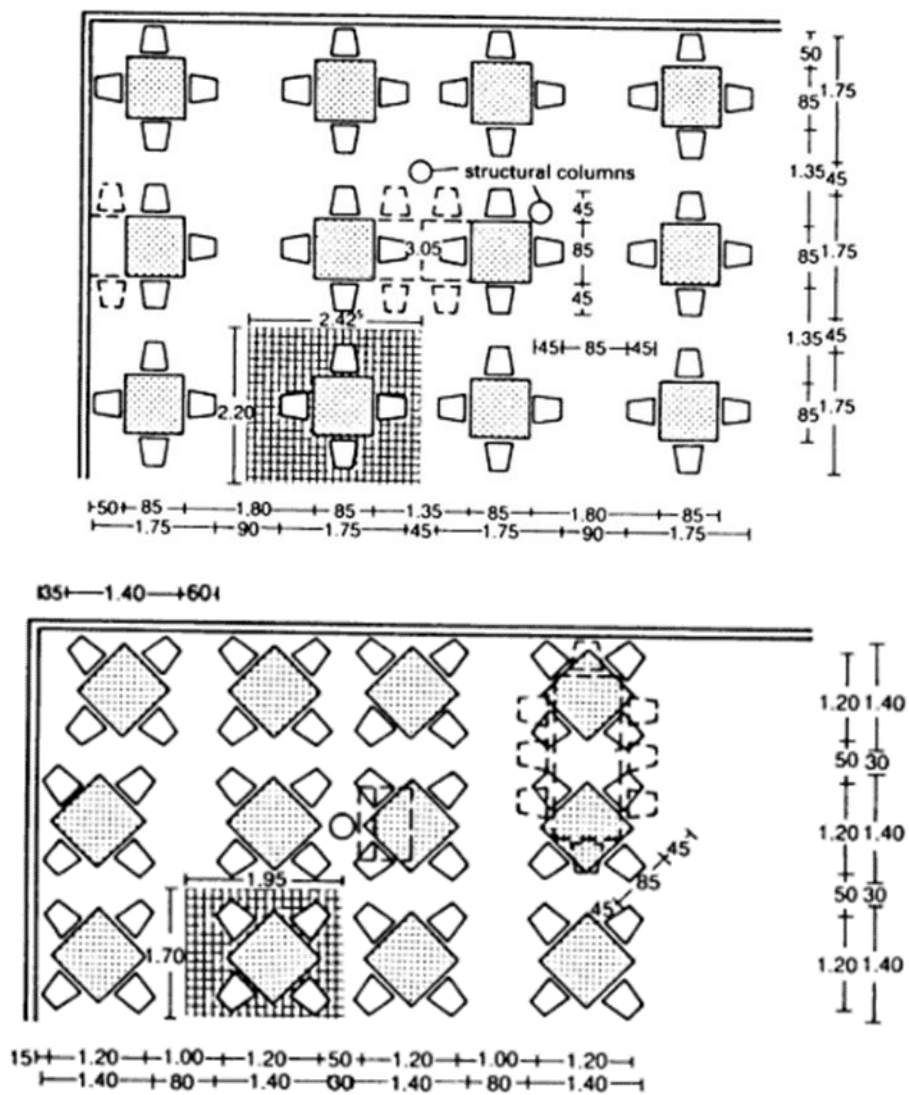

Figure 14: distribution of the furniture

Types of restaurants,

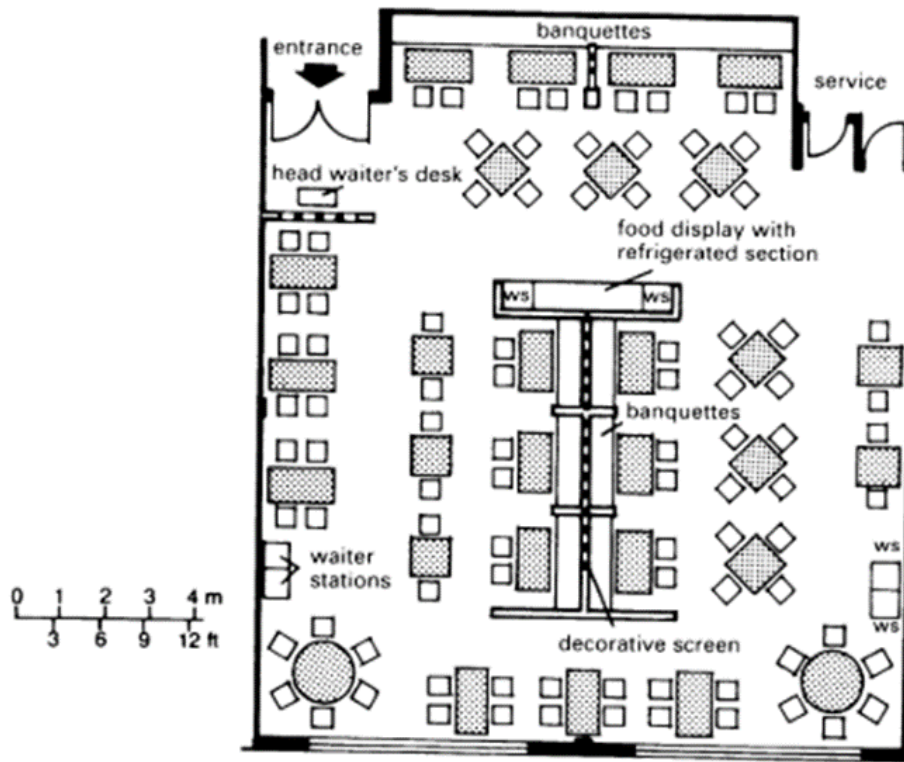

Figure 15: traditional restaurants with 110 set

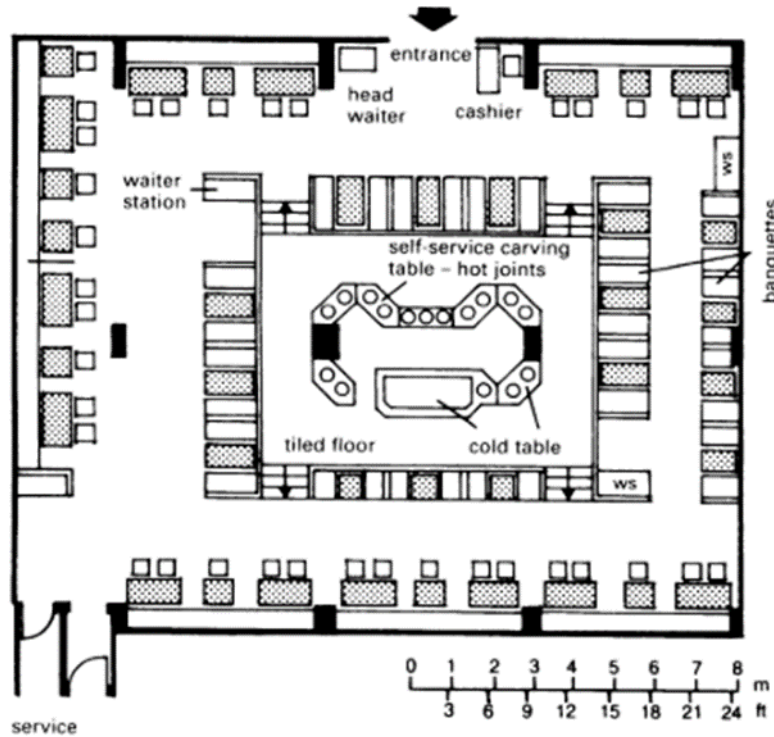

Figure 16: restaurant seating 124 with self-service carving table (Neufert and Ernst 2012)

2.3 Computers and network spaces

The main and important special spaces in the communication company is the place of servers and computer equipment's. This devices and equipment need a very special care and choose the best space for it. The space must be designed to be naturally ventilated on the upper stories and dry enough to keep this equipment work in well situation.

The best environment for these devices is that the temperature of the place must be between 25°C to 35°C, thus the environmental design must be taken into consideration.

Also, storage places must be in a dryness environment and Moisture-free to keep the equipment on a good situation.

The space of these places is depend on the size of the devices and equipment's.

2.4 Parking's

The parking place is where the cars stopped and it might be under the ground floor to save areas and for best exploitation when there no enough spaces outside, also it might be outside when there are enough spaces. This parking will be for the employee's cars.

The standards car size is shown in figure 17 below.

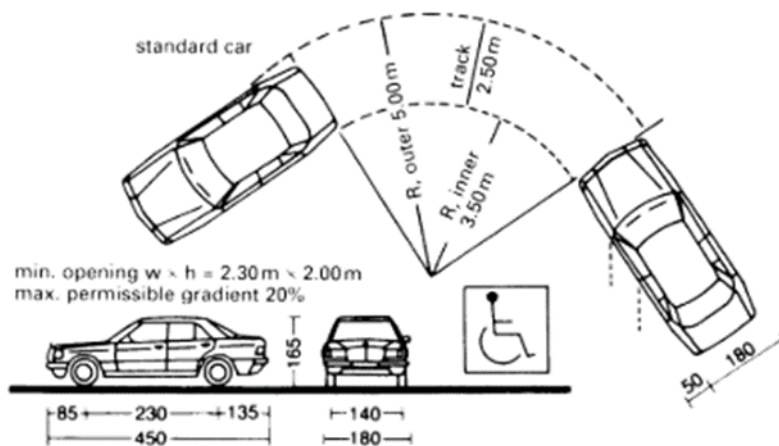

Figure 17: standers car size (Neufert and Ernst 2012) (Michael and Donald 2004)

From figure 18 the size of the standard car is 2.3m width and 5m length and one the parking cars must have enough space for turning and getting out without making any disturbance for other cars.

The parking have many types and forms shown in figure 18 below.

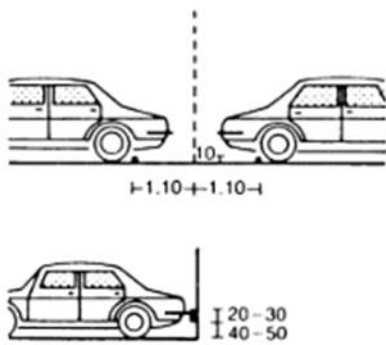
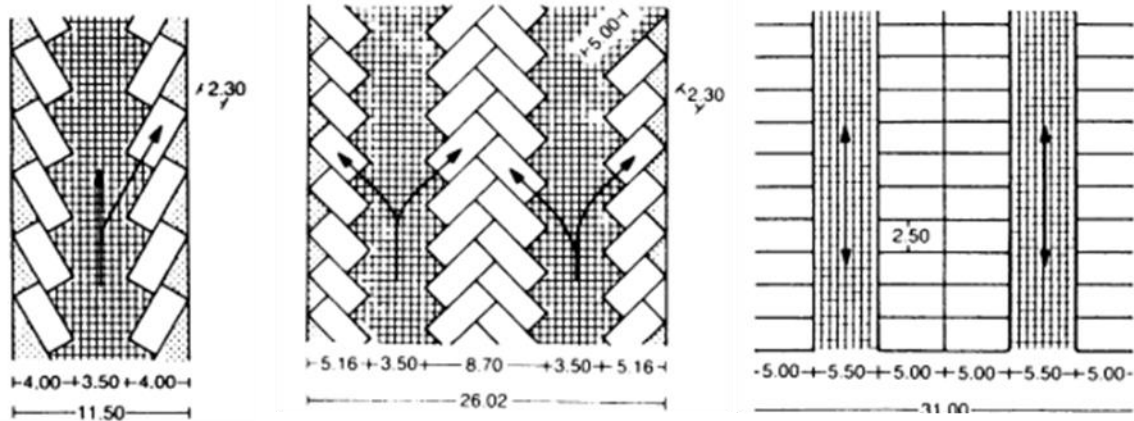

Figure 18: parking standers. (Neufert and Ernst 2012)

Special consideration should be given to the need of disabled people, the special spaces for the disabled persons should be a minimum of 4.8 meters (and up to 6.6 meters) long, with access to the rear of the vehicle where wheelchairs are often stored, the spaces should be 2.4 meters wide plus a minimum of .9 meters (and up to 1.2 meters), wide cross-hatched strip to facilitate the transfer of wheelchair passenger figure 19 below show that. (Michael and Donald 2004)

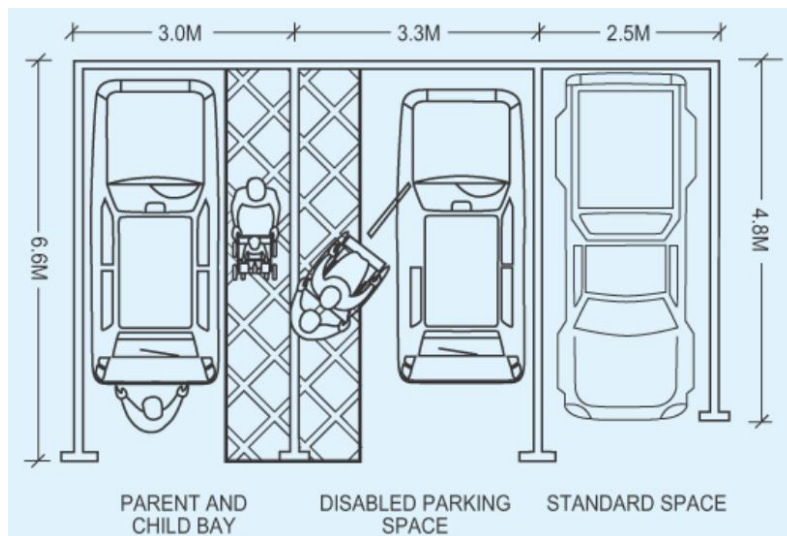

Figure 19 :standard design for disable people

In parking where exhausted gases like Carbon Monoxide (co) and NOx from the vehicles are very dangerous, thus proper ventilation of the area is very important.

Parkings with floor area more than 50 m² should have mechanical or forced ventilation with fans. But the smaller parkings with areas less than 50 m² does not require any mechanical ventilation because it can have natural ventilation. (Grondzik, et al. 2010)

The standard required air changes per hour as a general rule of thumb:

- Air changes per hour in a storage garage should be at least 4 to 6
- Air changes per hour in a repair garage or workshop should be at least 20 to 30

2.5 Stair case

The stairs are another solution which supports vertical movement within the office building, stairs have a special use when the electricity cut off, in this case the mechanical equipment such as elevators and escalators cannot work, and thus the stairs are the unique solution.

For the emergency cases (fires and earthquakes), the stairs should be exterior to avoid a lot of injured.

Stairs are the primary means of vertical travel during fire emergencies and are generally effective and reliable.

Minimum width of stairs for hotels, offices, educational buildings, theaters, cinema halls should be 1.5 meters while minimum width of stairs for institutional buildings and hospitals etc. should be 2 meters. (Neufert 2012)

Implies that we have to select the type of building and rise to calculate the dimension.

Many shapes of staires can be used to support movement and decoration, every shape have standard dimensions and calculations which shown in figure 20 below

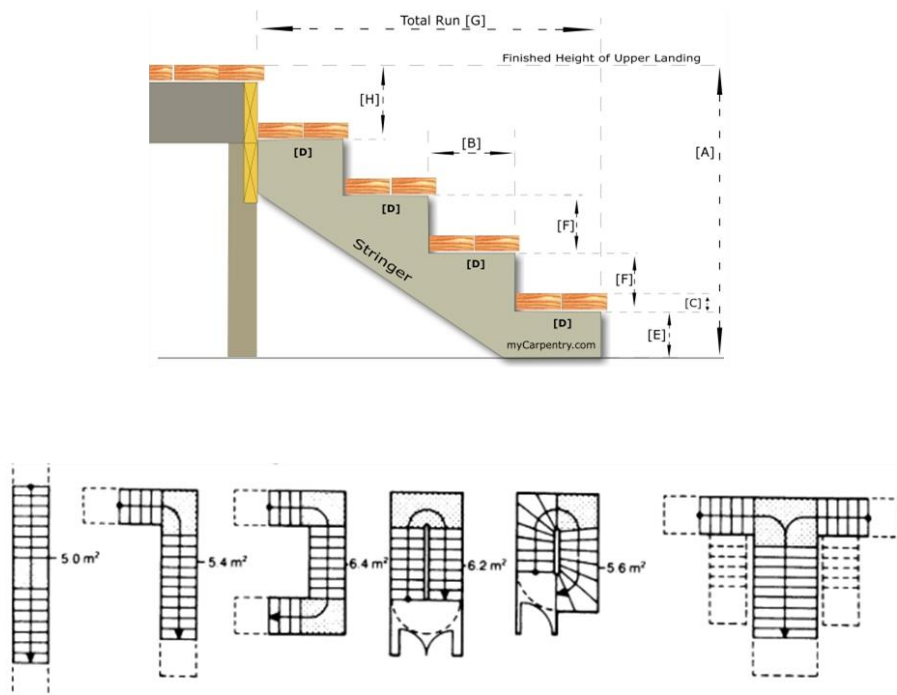

Figure 20: shape of stairs

2.5.1 Standards of design the stairs:

We must take into consideration the standard step of an adult on a horizontal plane, on ramp the step is reduced proportionately (desirable slope 1:10-1:8), optimum rise to tread ratio 17/29 as shown in figure 21.

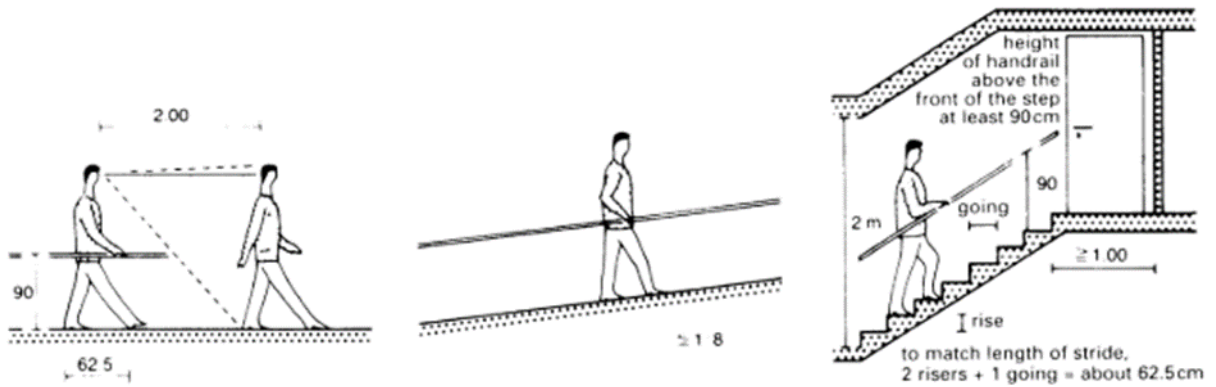

Figure 21: stair recommended design. (Michael and Donald 2004)

If stairs are narrow or curved the distance of the line of walk to the outer string should be 35-40 cm, if stairs are straight and wide the distance of walk to the handrails should be 55 cm, stairs width allowing two people to pass, stairs width allowing three people to meet and pass as shown in figures 22 and 23.

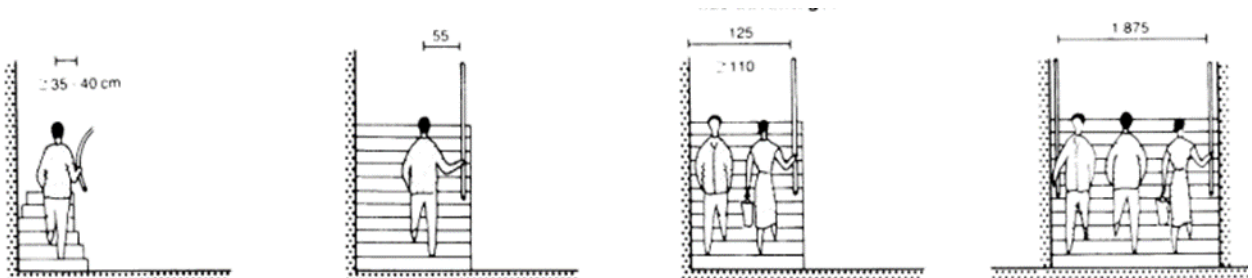
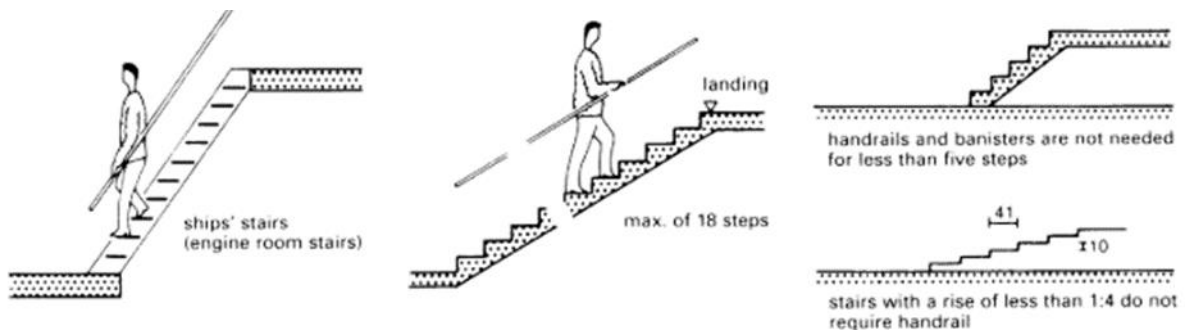

Figure 22: stair recommended design (Neufert and Ernst 2012)



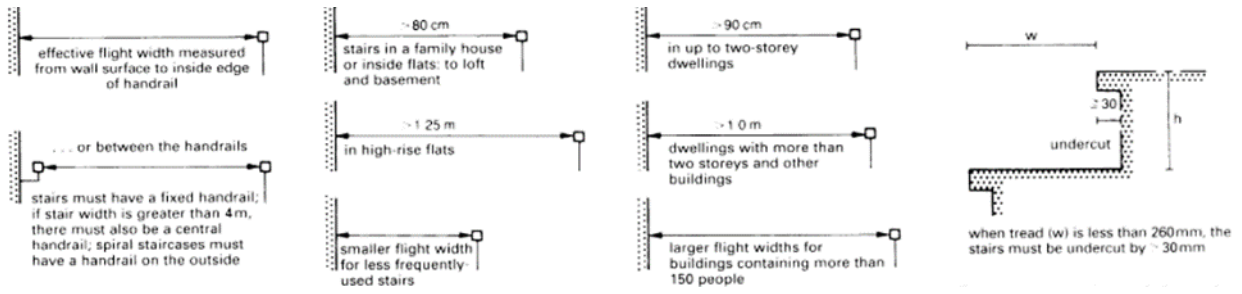

Figure 23: stair recommended design (Neufert and Ernst 2012)

2.6 Envelop

Sometimes the environmental design governs the shape and decoration of envelope design to make the design behaves as a green building, thus we must take the environmental and architectural design in the same level, that means when we think about the architectural form we have to think about environmental design such as the dimension and places of windows and cantilevers for shading. In addition, if we are going to think about insulation issue we have to take the thickness of envelope into consideration. Solar design needs thinking about south elevation and its shape and its design. Similarly, acoustical design effects on thickness of envelope, in addition architectural fragments effects on ventilation and day light, all of these consideration must be connect to each other to investigate what we called green building.

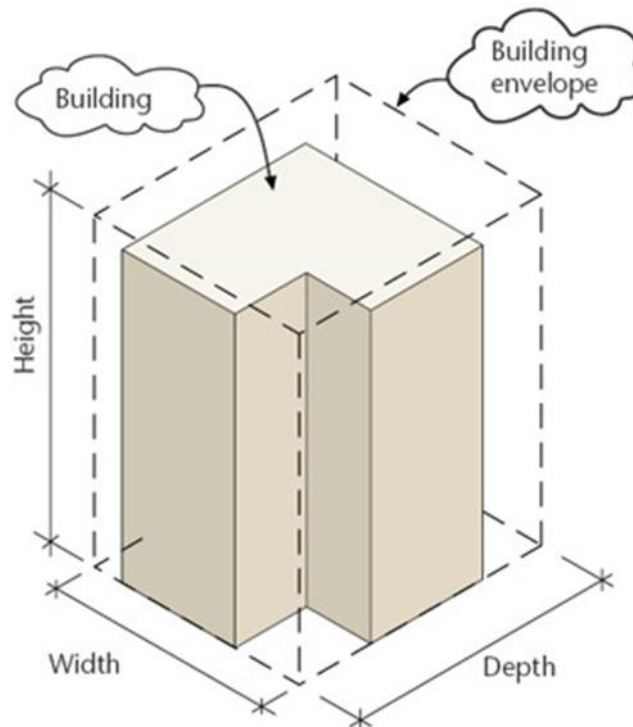

Figure 24: building envelop

2.7 Entrance

The entrance of the building must be widely and beauty and comfortable for motion and movements. The entrance must also positioned on a specific direction that the environmental and architectural design requires. (Neufert 2012)

3.1 What Is Structure?

First step for design we have to select the material, second is to select structural system, third is to compute loads such as dead load , live load ,wind load ... etc. , fourth modeling and analysis, means how to convert the structural type to model

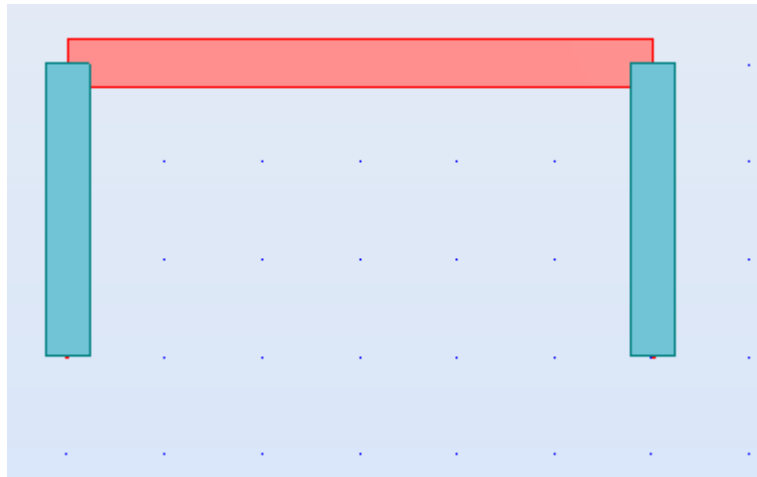

Figure 25: modeling of the structure

Finally, design, in this step we calculate internal forces to get dimensions. Design code must be taken into consideration.

3.2 Foundation

Foundation is the sub structural system that carry the building, it constructed under surface of the ground, also it main function to redistribute and transfer loads to the ground.

The structure of building should be supported from the ground and this support called the foundation of the building. The foundation supports the structural system and it is designed according to the characteristics of soil (bearing capacity of soil)

Foundation work according to the principle of pressure, the more area we have the less pressure we get.

Usually loads are distributed to soil at 45 angle according to figure below

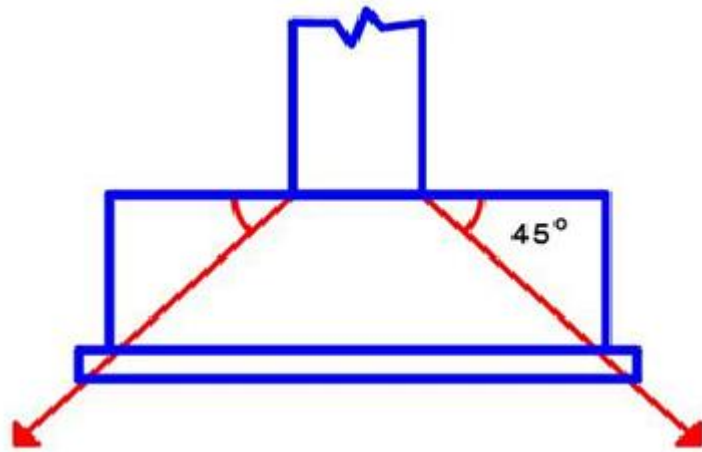

Figure 26: single footing

Choosing a foundation system depends on several factors:

1. Amount of loads of the building
2. Type of structure (bearing walls, columns)
3. Type of loads (Static, dynamic, vibrating)
4. Location of the building (for example near cliff)
5. Bearing capacity of the soil (according to soil test)
6. Type and components of soil (for example water, salt)
7. Adjacent structures (type and location)
8. Infra structures (such as pipe lines, cables)
9. Available materials and technology
10. Cost.

Foundations are constructed according to the following stages:

1) Site Preparation:

We have to clean the site from, rocks, trees and any other obstacles, and then relocating any existing infra structures such as cables or pipelines, after that leveling the site as required. Finally laying out the centers for each foundation base (footing base).

2) Excavations:

Excavation for each footing base according to the design level and shape of the foundation base.

3) Footing Construction:

After the excavations are made according to the foundation design level, the foundation base is constructed on to the following layers:

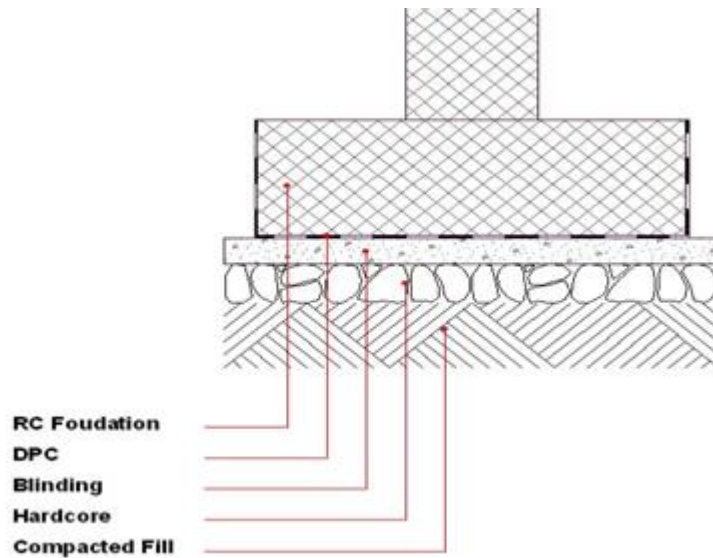

Figure 27: the construction of footing

Types of foundation systems:

The most types are used for foundation systems:

- 1) Isolated footing.

Usually isolated footing have a shape of square or rectangle, they are used as foundations for columns (large bearing capacity, less loads).



Figure 28: top view of single footing tied and spiral

- 2) Combined Footing:

When two columns are close to each other, one footing base is made for them.

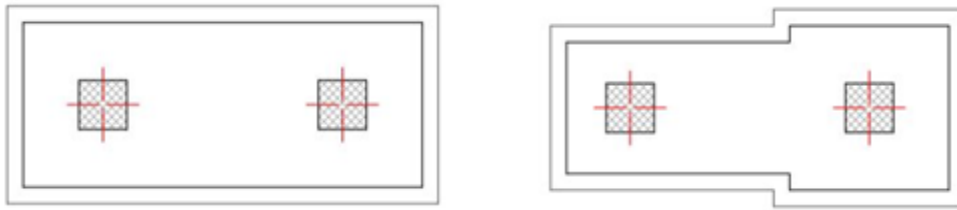

Figure 29: combined footing top view

3) Continuous Footing:

Continuous footing is used when we have several columns on the same line center and the distance between them not enough to make them as isolated.

4) Raft foundation

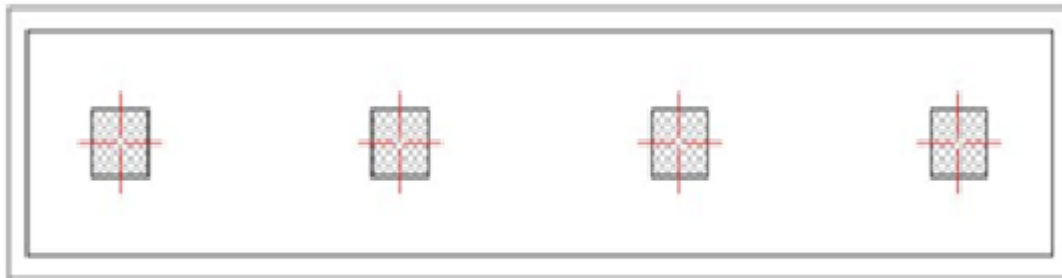

Figure 30: raft foundation top view

Raft foundation is usually used when the soil is weak and when the total areas of footings for the columns are equal or more than of 60 per cent of the total area of plane building. raft foundation is constructed by making one foundation base for the whole structure.

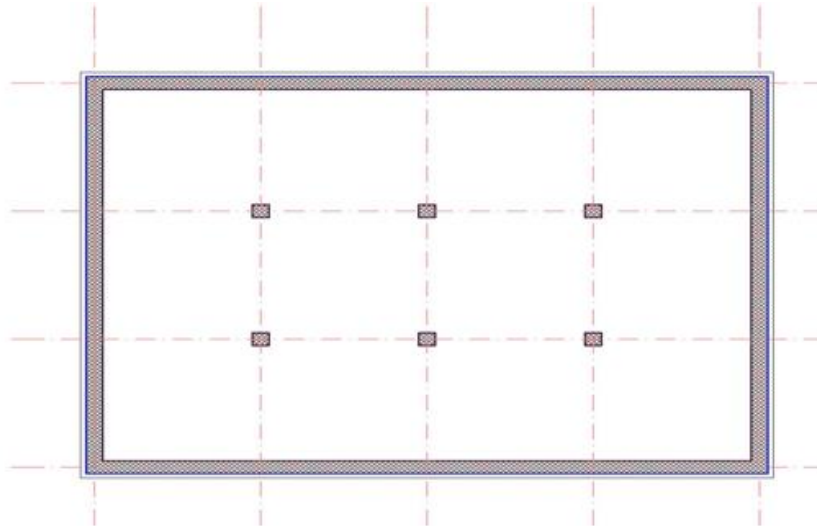

Figure 31: top view for mat foundation

5) Pile foundation:

Pile foundation is used when the soil is too weak with low bearing capacity such as very deep clay soil. Therefore piles can be used to transmit the loads to lower level of sub soil.

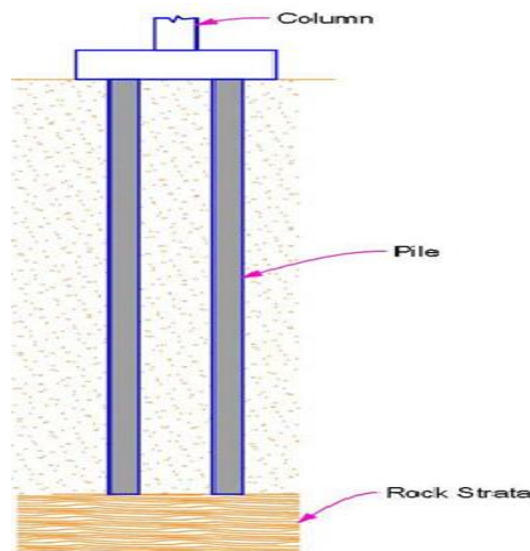

Figure 32: pile foundation

3.3 Structure

Structure is basically defined as “a device for channeling loads that result from the use or presence of the building in relation to the ground”. Many different structural systems are used in architecture, the type them used depends on some factors such as the height of the building, its load bearing capacity, the soil specifications and the building materials.

There are basically two kinds of structural systems:

- a. The masonry systems in which the walls are carrying the loads, and

b. The frame systems in which the building has a structural system (built out of reinforced concrete or steel) that carries all the weight.

In other way, we can list the structural systems as such:

1. Masonry (stone, brick, prefabricated concrete units,):

In this system the walls carry the whole weight of the building, the walls are thick and the buildings are heavier. The frame systems enable to design flexible and more wide inner spaces.



Figure 33: masonry wall construction

2. Reinforced concrete frame:

Concrete is a mixture of a certain components; cement, water, sand and or aggregate. The quality of concrete is determined by the percentage of these components. In order to make concrete more strength and durable, it is combined with steel reinforcement and then it is called reinforced concrete. Reinforced concrete frame can span large distances. Thus it could be used in engineering works such as bridges or highways, alongside buildings.

In this system, the reinforced concrete frame carries the floor and roof slabs. Since the inner and outer walls don't carry any load, they could be placed freely as the architect desires.



Figure 34: concrete structure

3. Steel frame:

Steel frame is considered more freedom to architectural design and enabled the construction of towers. Steel is a flexible, strong and durable material and in steel frames the supports are slender. Steel frames could span large distances. Steel units are produced in factories and assembled in the construction site. Steel beams could be in types of I beams, H beams, T beams, channel beams, pipes...etc.



Figure 35: steel construction

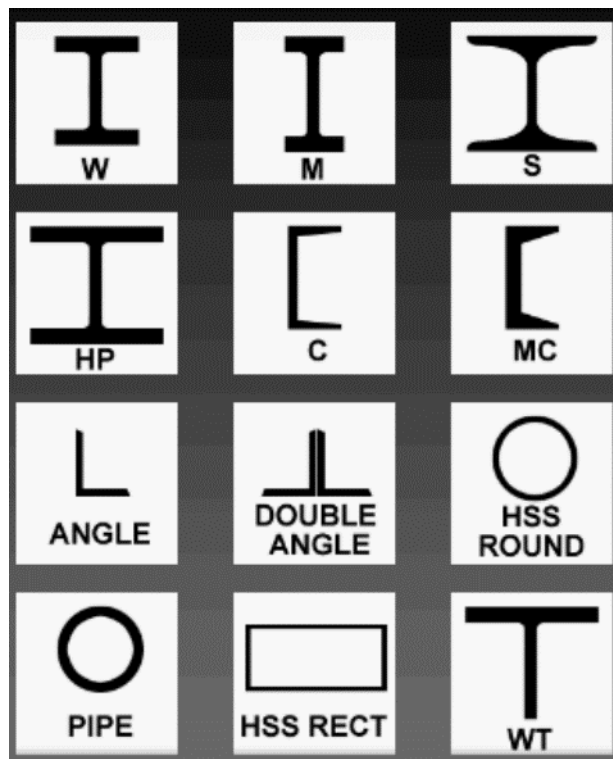

Figure 36: types of steel beams

3.4 Structural stability and efficiency

The design of structural frames to resist lateral and vertical loads on buildings is a complex process which takes a multitude of requirements. As a result, there are a number of structural systems which make a tall building stand up.

Design methods for tall buildings have been developed to cope with earthquakes in places. The main issue for stability is wind. The effects of lateral loading on the building frame are dramatically magnified for towers over about 60 stories. The efficiency of the building frame has the greatest influence on the embodied energy of a tall building.



Figure 37: high rise stable concrete building

“In the US, the development of steel led to its use as the favored material for high-rise structures. In broad terms, steel-framed buildings with a rigid frame can be economical for medium rise buildings up to 20 stories; a vertical steel shear truss at the central core of the building can be economical for buildings up to 40 stories; and a combination of central vertical shear trusses with horizontal outrigger trusses is most suited for up to 60 stories, this being the most common form of tall building structure in the US. For even taller buildings, it becomes essential to transfer all gravity loads to the exterior frame to avoid overturning effects. Rigid framed tubes, braced tubes and bundled tube structures have been developed to reach up to over 100 stories in buildings such as the Hancock and Sears towers in Chicago.” (strategies of architectural design and analysis 2007)

For tall building specially the structural system can be divided into two main categories exterior structures and interior structures. This category is based on the distribution of the components of the primary lateral load-resisting system over the building. A system is called an interior

structure if the major part of the lateral load resisting system is located within the interior of the building. By contrast if the major part of the lateral load-resisting system is located at the building perimeter, a system is called an exterior structure.

“However, that any interior structure is likely to have some minor components of the lateral load-resisting system at the building perimeter, and any exterior structure may have some minor components within the interior of the building”. (strategies of architectural design and analysis 2007)

Interior structure:

The two basic types of lateral load-resisting systems in the category of interior structures are the moment-resisting frames and shear trusses/shear walls. These systems are usually arranged as planar assemblies in two principal orthogonal directions and may be employed together as a combined system in which they interact. Another very important system in this category is the core-supported outrigger structure, which is very widely used for super tall buildings.

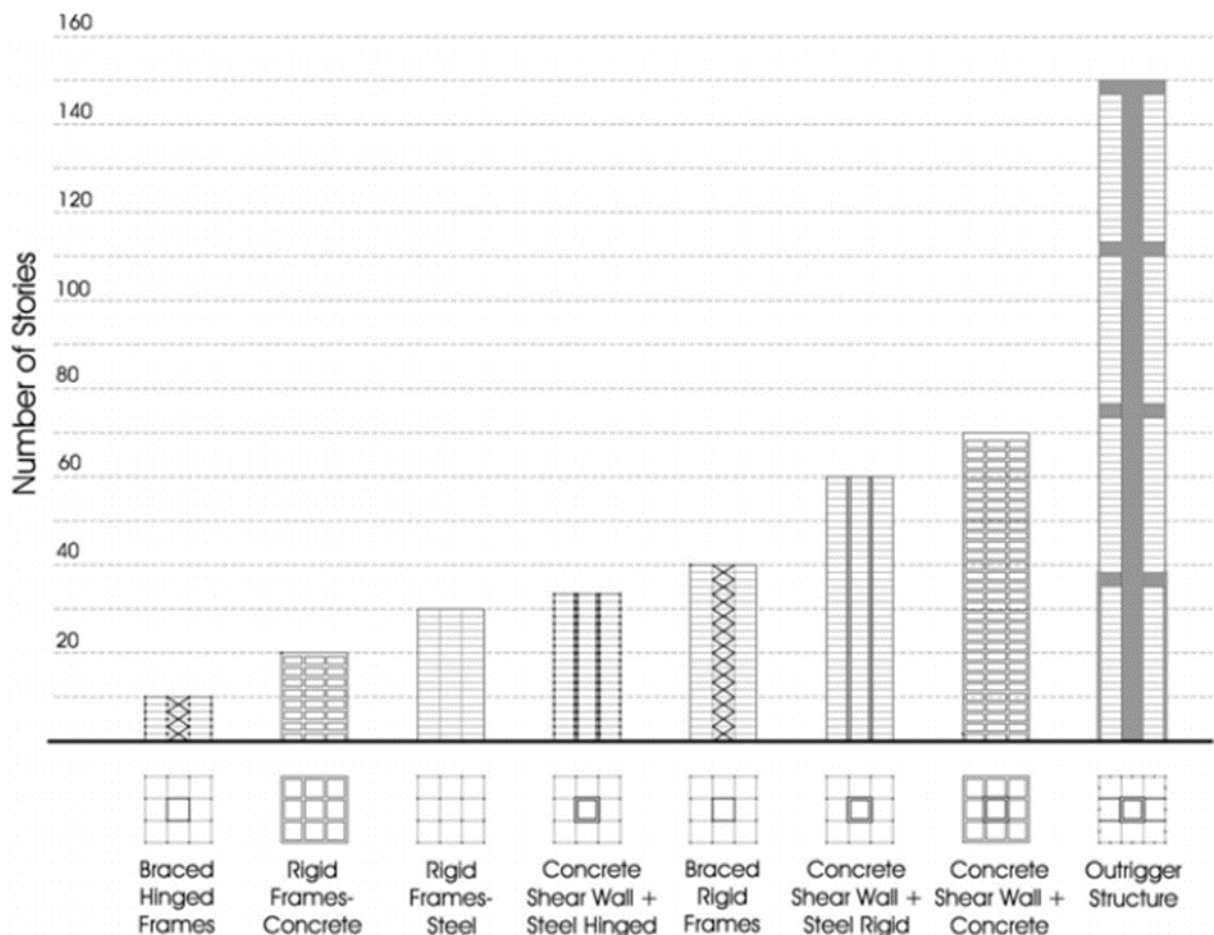

Figure 38: Interior structures (strategies of architectural design and analysis 2007)

Exterior structure:

In tall building the nature of building perimeters has more structural importance than in any other building due to their rising, it more sensitive to lateral forces especially wind load. Thus it is better to concentrate as much lateral load-resisting system components as possible on the perimeter of tall buildings their structural depth and resistance to lateral loads.

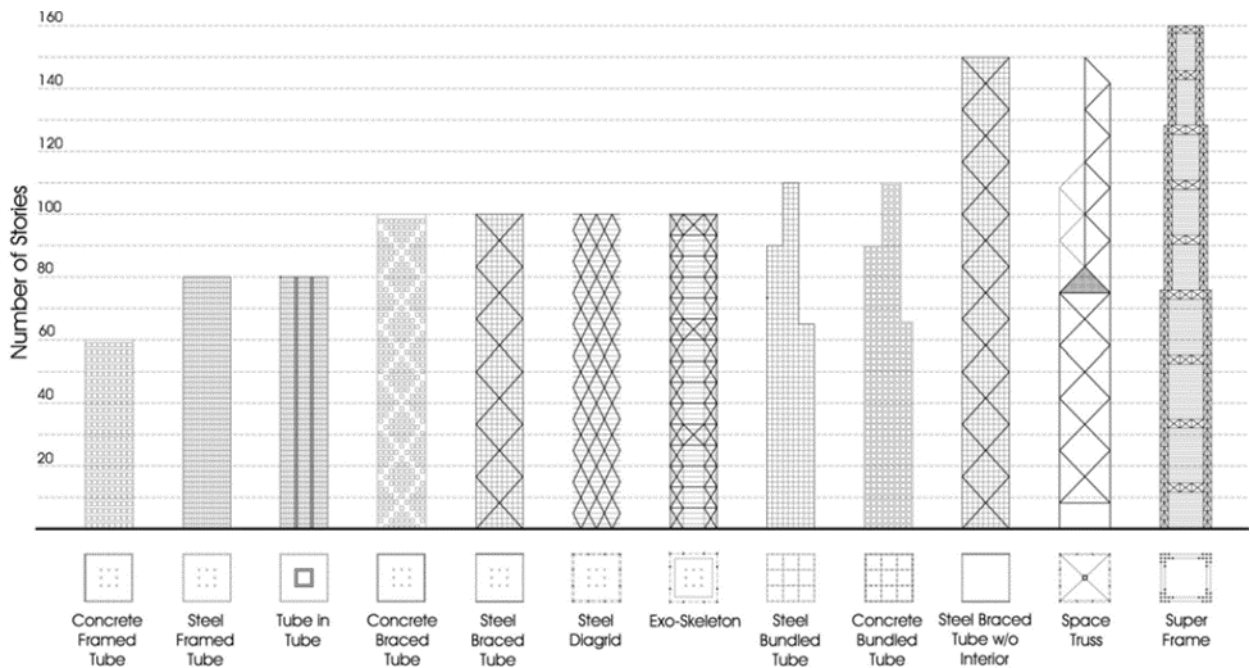

Figure 39: Exterior structures (strategies of architectural design and analysis 2007)

3.5 Walls

Walls are defined as the boundaries on the outside and the inside of the building. Load bearing walls in the masonry systems carry the building’s structure, floors and the roof like shear walls, while non-load bearing walls are used for separating spaces. Exterior walls can be built with various materials, such as concrete, brick, stone etc. There are also steel and glass curtain walls. Exterior walls should be built with care since they are very important to protect the building from external factors such as the weather and wind and the difference in temperature between the inside and outside of the building.

3.6 Roofs

Roof is the last layer that covers the building. The function of the building and the climatic conditions decisively effect on the shape of the roof. If the nature of the climate has heavy rains and snow, the roofs tend to have steep angles, or if the climate is sunny and has less rain and snow the roof might be flat. Roofs can be carried by timber frames or steel frames or load bearing walls, etc. and they can be covered with various materials such as copper, ceramic tiles, aluminum sheeting, laminated glass and precast concrete.

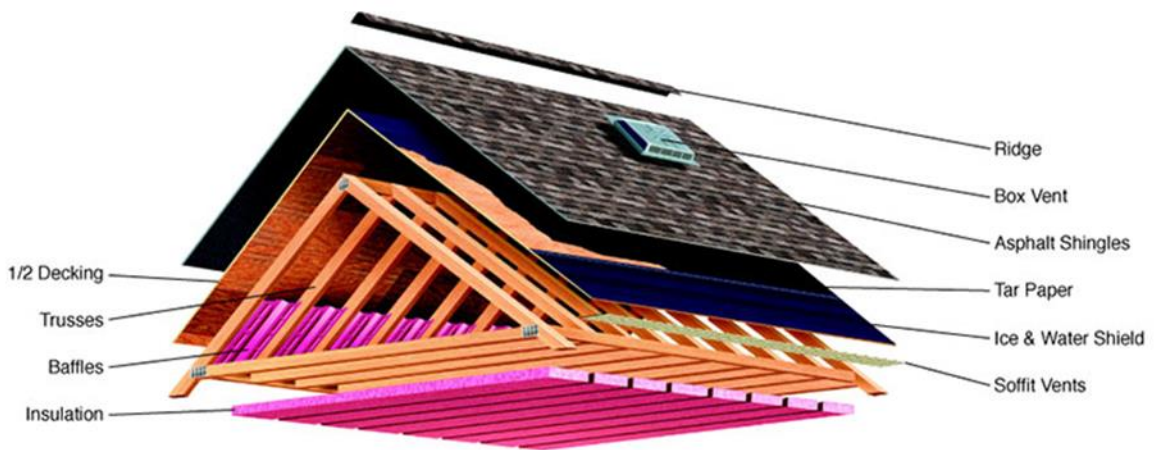

Figure 40: Roof components

There are 3 roof types according to their inclination levels:

1. Flat roof: if the roof angle is 5 degrees or less.
2. Semi inclined roofs: if the roof angle is between 5 to 40 degrees.
3. Steep roofs: if the roof angle is more than 40 degrees.

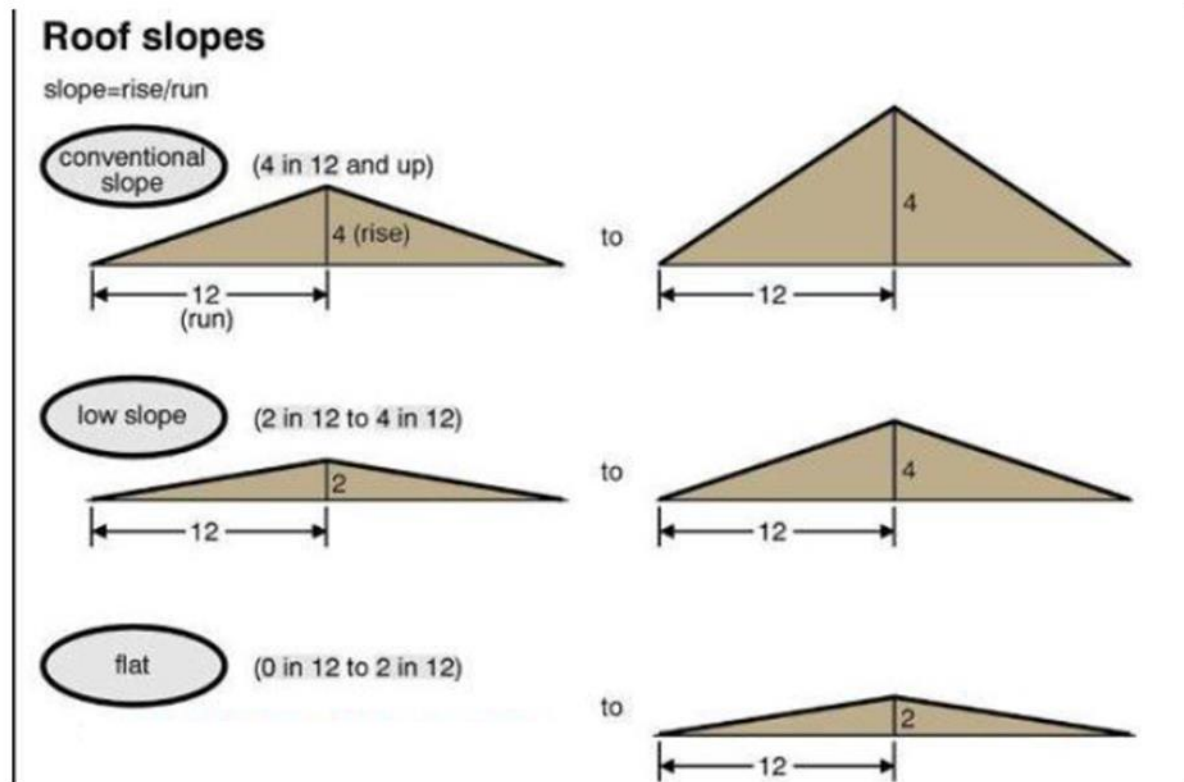

Figure 41: roof level and slope

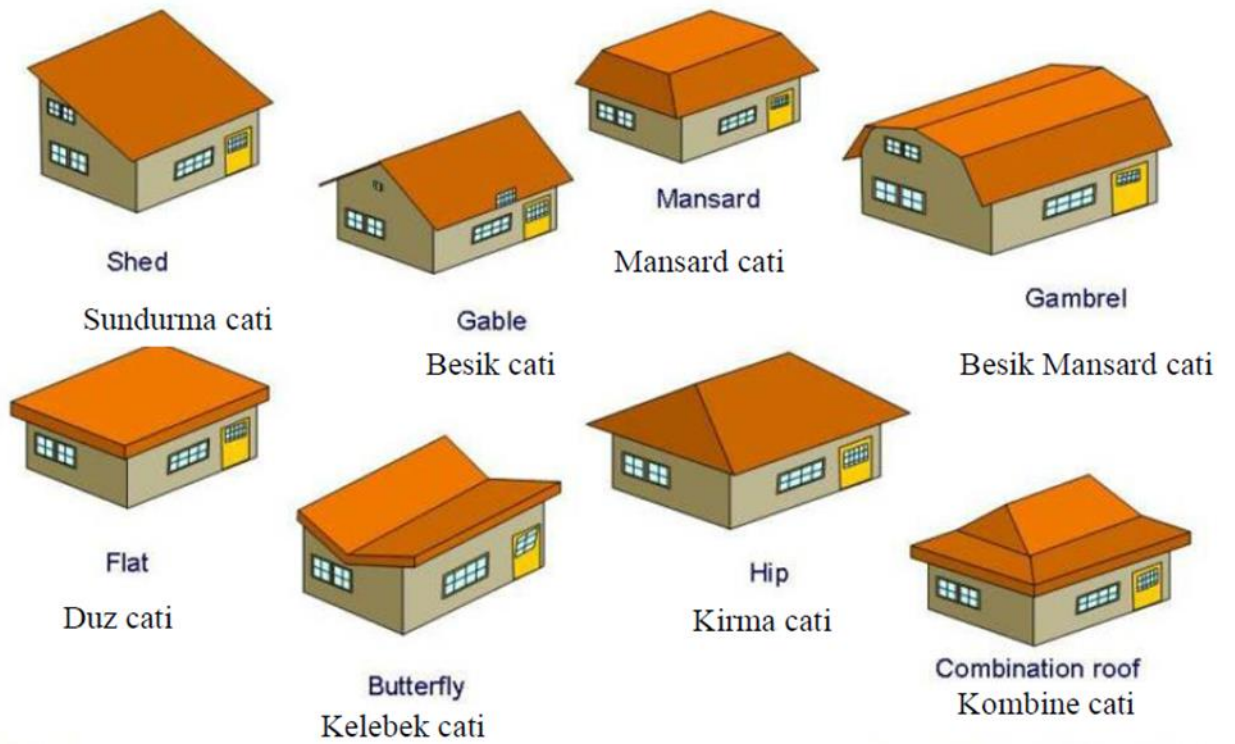

Figure 42: Roof types according to their forms

Examples of different structural systems:



Figure 43: Brick masonry structure



Figure 44: Stone masonry structure



Figure 45: Timber frame structures



Figure 46: Reinforcement concrete frame



Figure 47: Steel frame

Mechanical requirements are very important issue in all types of buildings, it look to guarantee on excellent level of comfort for occupants. Its concedes by understand how air surface temperatures, air motion, and humidity are related to heat transfer, in addition it interested by occupants transportation in the building and the darning system adopted in these building.

4.1 Heating, ventilation, and air conditioning

Heat transferred by four ways, first conduction and it is primarily dependent upon surface temperature, second convection which is primarily dependent upon air temperature, air motion, humidity, thirdly radiation which is primarily dependent upon surface temperature, orientation to the body, finally evaporation humidity, air motion and air temperature.

The human thermal comfort is measured by four environmental parameters: relative humidity, radiant temperature, air speed and dry-bulb air temperature.

How can comfort be ensured at each workstation in an office or wherever people spend a lot of time?

These locations are very sensitive to heating, cooling and ventilation.

The temperature of our skin under ordinary conditions is in the high 20 °C, so *our sense of touch works against many passively heated surfaces in winter* this leads to feel cool even though they are warmer than room air temperature.

Natural ventilation cooling has two variations: cross ventilation and stack ventilation. Cross ventilation is driven by wind based on pressure difference.

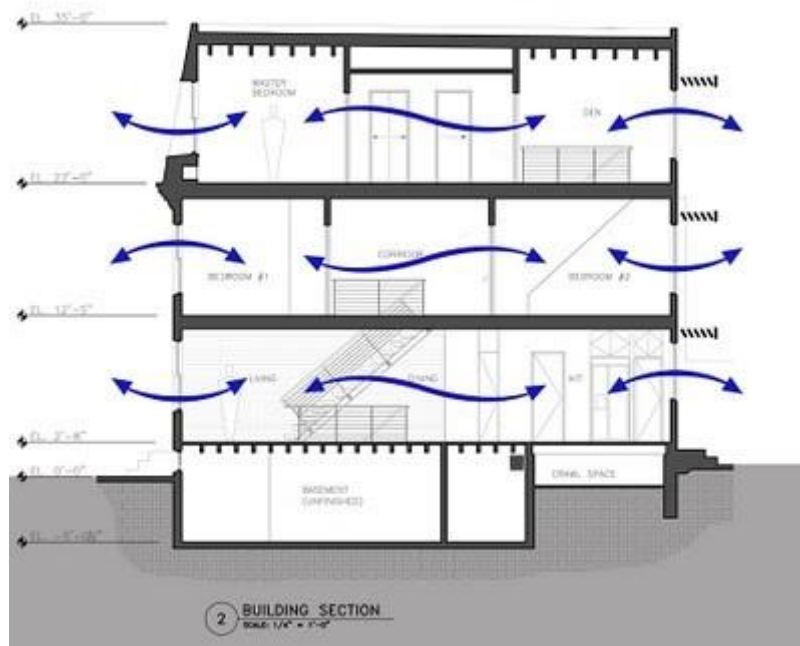

Figure 48: cross ventilation (Grondzik, et al. 2010)

Stack ventilation depends upon very low openings to admit outside air and very high openings to exhaust air based on temperature difference.

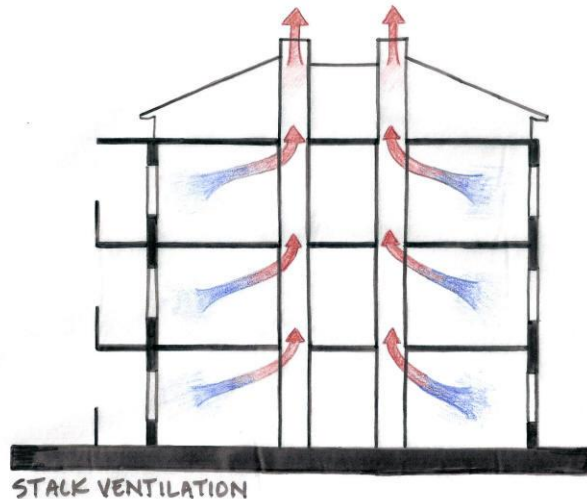

Figure 49: stack ventilation (Grondzik, et al. 2010)

Stack ventilation is where air is driven through the building by vertical pressure differences developed by thermal buoyancy. The warm air inside the building is less dense than cooler air outside, and thus will try to escape from openings high up in the building envelope; cooler denser air will enter openings lower down. The process will continue if the air entering the building is continuously heated, typically by casual or solar gains.

Stack ventilation is one of the two natural ventilation mechanisms, the other being wind-induced. Since the same openings may contribute to both stack and wind pressure induced flows, they must not be considered in isolation.

The effectiveness of the stack effect, i.e. the volume of air that it drives, is dependent upon the height of the stack, the difference between the average temperature of the stack and the outside, and the effective area of the openings. The mathematical formula is given in the Design Procedure.

Stack ventilation occurs naturally whether we design it or not, and has been consciously used for centuries, in traditional and vernacular buildings ranging from Indian tepees to churches . However, modern analysis and design advice greatly extends its area of application to much larger buildings, with more exacting demands.

Direct gain means some south-facing glass to achieve direct gain to building and its ample daylight and view to the south, *Indirect gain is less popular than direct gain because it admits much less daylight and lacks a view to the south.*

Day lighting may be the most clear of all on-site energy sources, by using windows in walls.

There is relation between day light ,cooling and heating and environmental side but quite complex ,if we want to extensive day light , this make a building to decrease its need for electricity and cooling , by contrast , increase the need for heating . (Grondzik, et al. 2010)

Cooling process done by mechanical air-conditioning, the psychometrics chart is used to size an air conditioner accurately by getting the environmental properties of the office space to make a calculation for volumetric flow rate and determine the size of the duct.

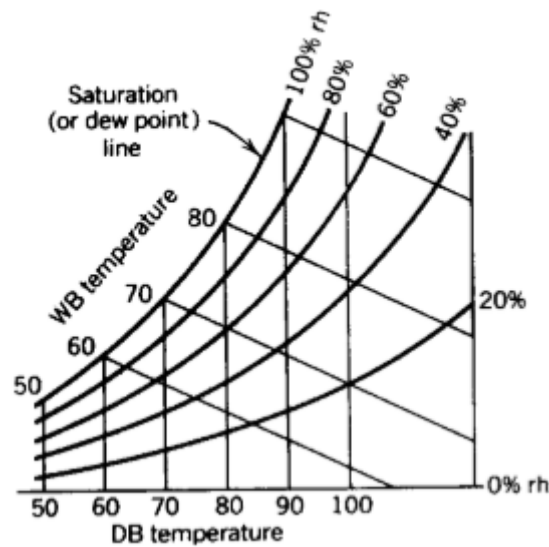

Figure 50: psychometrics chart (Grondzik, et al. 2010)

Heating load can be calculated from lights, people, and equipment, heat gain through glass due to ventilation or infiltration, through building envelope.

Very important thing is to calculate the U- value¹ which reflect the thermal Transitional for materials, and can be determined from the thermal resistance R² or K³.

Large- building HVAC is showing several ways to solve heating and cooling problems one is the solutions is using mechanical equipment with natural ventilation and day- lighting.

Central versus Local Systems require one or several large mechanical spaces and usually found in basements or on roofs the noise, heat, and other properties of a different mechanical rooms can be controlled easily, because a few locations are concentrated to the machinery.

Distribution trees, HVAC system choice is govern by the amount of space the system, sometimes distrusting small equipment easier than distrusting trees.

¹ U-value is the thermal Transitional which equal the inverse of resistance

² R is the thermal resistance which equal the thickens of the material used over K

³ K is the thermal conductivity.

4.2 Elevators



Very important decisions must be taken into considerations such as elevators and the escalators to achieve service for passengers. The decision that must be very important and must be taken into consideration is to select the best and safest system for the vertical transportation equipment.

More than any other element of construction, elevators are governed by strict codes. “The last resource in the United States is the American Society of Mechanical Engineers’ ANSI/ASME Standard A17.1, Safety for elevators and escalators, the latest version of which should be in every architect’s and engineer’s working library. The code has legal force in most parts of the United States. Two related code standards should be noted. ANSI/ASME Standard A17.3 covers existing elevators and escalators, and Standard A17.4 covers emergency evacuation of passengers from elevators”. (Michael and Donald 2004)

There are many types of elevators. Hydraulic elevators which used for low rise building and residential because it’s slow speed and simple. The other type is roped elevators which used in high rise building and multi stories.

The elevators size, capacity and speed depend on the building type and the passengers that the elevator will transport in the unit of time. And, the codes give the following tables – table 6, 7, 8, 9 – to evaluate the number of elevators and its capacity and speed needed for the buildings:

Important definitions:

Average lobby time or average lobby waiting time. The average time spent by a passengers between arriving in the lobby and leaving the lobby in a car. This is a key selection criterion.

Handling capacity (HC). The maximum number of passengers that can be handled in a time given period—usually 5 minutes. (Grondzik, et al. 2010)

Interval (I) or lobby dispatch time. The average time between departures of cars from the lobby.

Registration time is the Waiting time at an upper floor after a call is registered.

Round-trip time (RT). The average time required for a car to make a round trip—starting from the lower terminal and returning to it.

Travel time or average trip time (AVTRP). The average time spent by passengers from the moment they arrive in the lobby to the moment they leave the car at an upper floor. This is a key selection criterion.

Zone. A group of floors in a building that is considered as a unit with respect to elevator service. It may consist of a physical entity—a group of upper floors above and below which are blind shafts—or it may be a product of the elevator group control system, changing with system needs.

All of these definitions must be taken into considerations to reach a good level of comfortable range.

Table 3: Minimum Percent Handling Capacities (PHC) (Grondzik, et al. 2010)

Facility	Percent of Population to Be Carried in 5 Minutes
OFFICE BUILDINGS	
Center city	12–14
Investment	11.5–13
Single-purpose	14–16
RESIDENTIAL	
Prestige	5–7
Other	6–8 ^a
Dormitories	10–11
Hotels—first quality	12–15
Hotels—second quality	10–12

Table 4: Car Passenger Capacity (p) (Grondzik, et al. 2010)

Elevator Capacity lb (kg)	Maximum Passenger Capacity	Normal Passenger ^a Load per Trip
2000 (907)	12	10
2500 (1134)	17	13
3000 (1361)	20	16
3500 (1588)	23	19
4000 (1814)	28	22

Table 5: Recommended Elevator Intervals and Related Lobby Waiting Time. (Grondzik, et al. 2010)

Facility Type	Interval (sec)	Waiting Time ^a (sec)
OFFICE BUILDINGS		
Excellent service	15–24	9–14
Good service	25–29	15–17
Fair service	30–39	18–23
Poor service	40–49	24–29
Unacceptable service	50+	30+
RESIDENTIAL		
Prestige apartments	50–70	30–42
Middle-income apartments	60–80	36–48
Low-income apartments	80–120	48–72
Dormitories	60–80	36–48
Hotels—first quality	30–50	18–30
Hotels—second quality	50–70	30–42

Table 6: Population of Typical Buildings for Estimating Elevator and Escalator Requirements. (Grondzik, et al. 2010)

Building Type	Net Area
OFFICE BUILDINGS	FT ² PER PERSON (M ² /PERSON)
Diversified (multiple tenancy)	
Normal	110–130 (10–12) ^a
Prestige	150–250 (14–23)
Single tenancy	
Normal	90–110 (8–10)
Prestige	130–200 (12–19)
HOTELS	PERSONS PER SLEEPING ROOM
Normal use	1.3
Conventions	1.9
HOSPITALS	VISITORS AND STAFF PER BED ^b
General private	3
General public (large wards)	3–4
APARTMENT HOUSES	PERSONS PER BEDROOM
High-rental housing	1.5
Moderate-rental housing	2.0
Low-cost housing	2.5–3.0

The other thing that must be discussed is the location, shafts, and lobbies for the elevators in the office building, the recommended location of the elevator is behind the stairs in palace that is easy to access and it might be after the reception lobby. Shafts of elevators have a standards dimensions based on its capacity and the company which create it. The figures below shows the relation between the lobbies and location of the elevators.

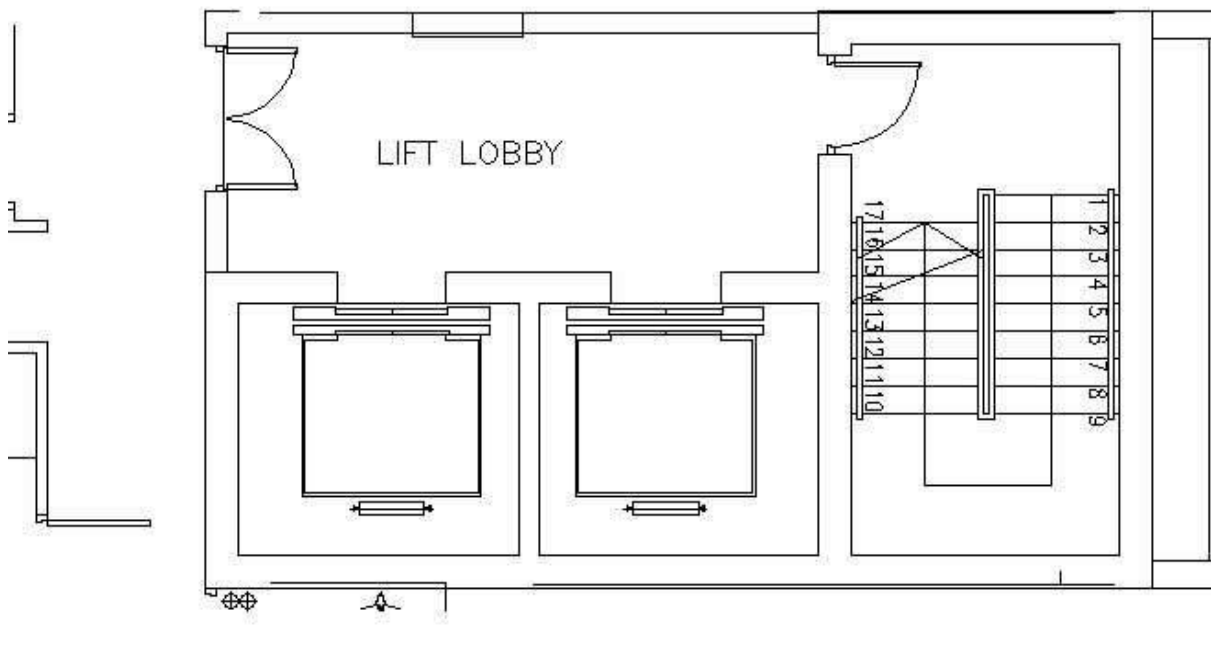

Figure 51: elevator distribution and location relationship

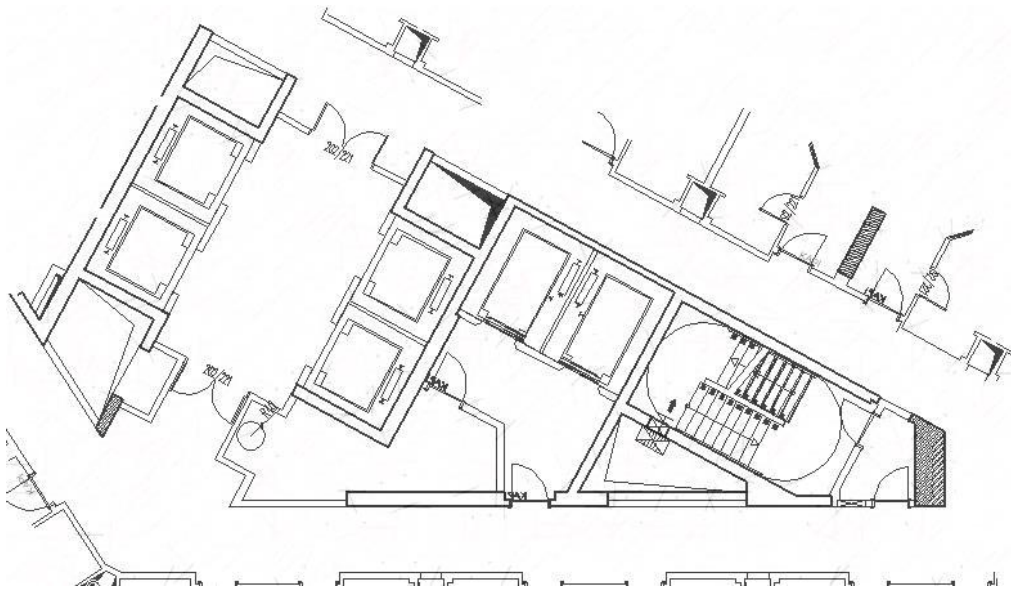

Figure 52: elevator distribution and location relationship

4.3 Drainage system:

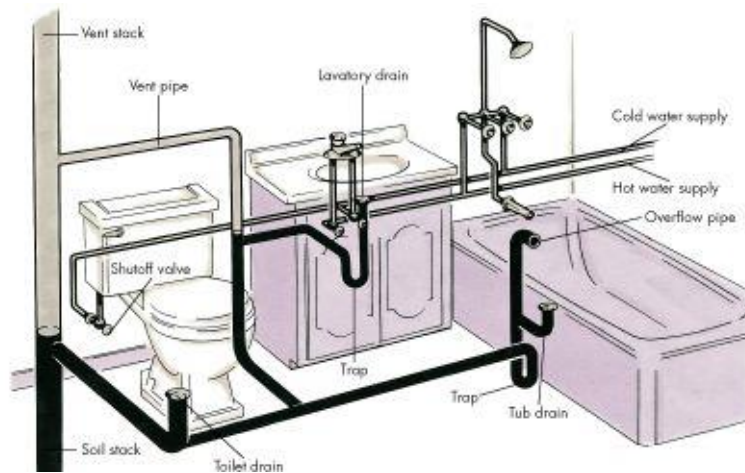

Figure 53: plumbing fixture.

Water drainage systems should be located at a suitable areas that don't effect on the structural side such that beams and columns.

The design of the sanitation fittings must be compatible with the structural element such as beams, columns and slabs... etc.

Drainage systems contain many shapes of equipment and needs such as fittings, tubes, and pipes

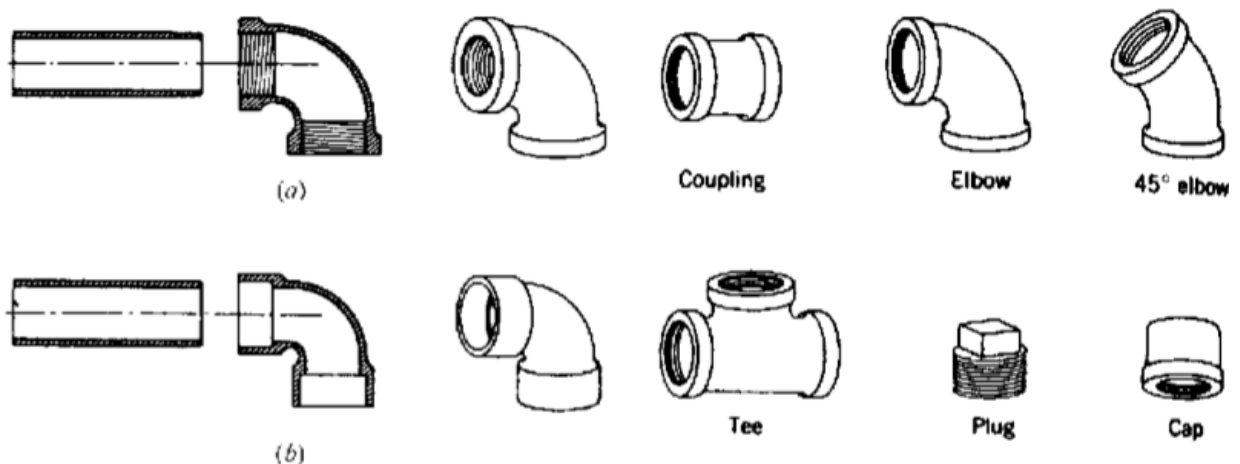

Figure 54: fitting used in the drainage system

Multistory construction, especially in office buildings, is often designed to be flexible and free of random partitions that would interfere with the periodic renovation of interior spaces and the relocating of dividing partitions. Building “cores” contain elevators, stairs, and shafts for plumbing, mechanical, and electrical equipment. Cores are often placed in the central section of the building, freeing the surrounding areas for access to daylight. A hole in the floor for each pipe is often chosen in preference to a slot or shaft. This method usually interferes less with the floor construction.

Offices often need a single lavatory or a complete toilet room for executives at locations away from the central core of the building. The greater the horizontal distance from the core, the more vertical clearance that will be needed to allow the drain to slope. When such vertical clearance becomes difficult, “wet” columns with a full complement of plumbing pipes offer a solution. If the pipes are to accompany a column in a steel building, structural coordination must be sought early in the planning if the pipes are to clear the structural framing of the floor

4.3.1 Sanitation of gray water and black water:

Gray water is wastewater generated from domestic activities such as laundry, dishwashing, and bathing, which can be recycled on-site for uses such as landscape irrigation and constructed wetlands. Gray water differs from water from the toilets which is designated sewage or black water to indicate it contains human waste.

In the buildings there must be separation between the gray and black water, and this indicate the loads of drainage system of the stacks, fittings, and traps used.

4.3.2 Vents

Vents are used in the drainage system To admit air and discharge gases, soil and waste stacks are extended through roofs, and a system of air vents, largely paralleling the drainage system, is provided. As in the case of drainage stacks, the ventilating stacks extend through the roof or vent through the drainage stack. The functions of venting are often misunderstood. It is true that one important purpose is to ventilate the system by allowing air from the fresh-air inlet (or from the sewer, if there is no house trap or fresh-air inlet) to rise through the system and carry away offensive gases. This provides some purification for the piping. However, several other purposes are served by the vent piping. The introduction of air near a fixture (and, in the case of circuit vents, at the branch soil line) breaks the possible siphonage of water out of a trap. (Grondzik, et al. 2010)

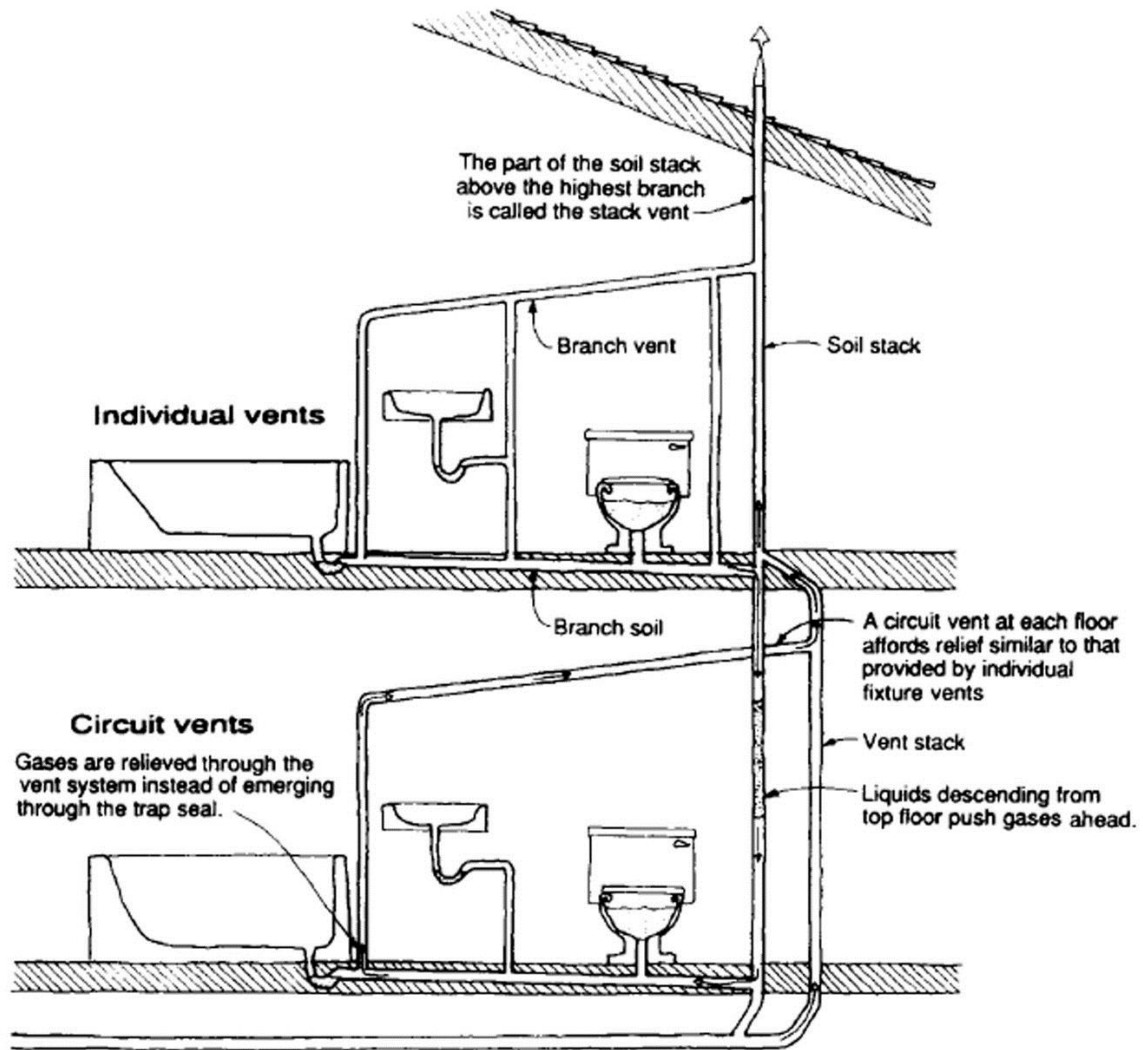

Figure 55: Sewer gas relief through vents. Gases pressurized by hydraulic action or by expansion due to putrefaction have an escape, *the* lower floor shows circuit vents, permitted by some codes, where one vent serves the entire branch.

CHAPTER 5: LIGHTING

Lighting or illumination is the application of light to achieve some practical effect. Lighting includes the use of both artificial light sources such as lamps and light fixture, as well as natural illumination by computing daylight.

Daylight is an important factor that influencing human behavior, health, and productivity, also designing with daylight can improve energy efficiency by minimizing the use of electricity for lighting as well as reducing heating and cooling load.

Electricity is expensive and of all building systems, lighting is typically the largest consumer of electricity. Natural light is free, but its availability fluctuates every day in both time and quantity.

The most basic goals in office space design are to create a place where work can be accomplished and communication can occur.

5.1 Windows

Are the most common way to inter daylight into a space. Their vertical orientation means that they selectively admit sunlight and diffuse daylight at different times of the day and year. Therefore windows on multiple orientation must usually be combined to produce the right mix of light for the building, depending on the climate and latitude. There are three ways to improve the amount of light available from a window.

1-Place window close to a light colored wall

2-Slant the sides of window opening to the inner opening is larger than the outer opening .



Figure 56: day light preview

5.2 Clerestory window

Another important element in creating day lighting is the use of Clerestory window. These are high, vertically – placed window. They can be used to increase direct solar gain when oriented towered the equator. When facing towered the sun, clerestories and other windows may admit

unacceptable glare. In the case of passive solar house, clerestories may provide a direct light path to polar- side (north in the northern hemisphere; south in the southern hemisphere) rooms that otherwise would not be illuminated. Alternatively clerestories can be used to admit diffuse daylight (from the north in the northern hemisphere) that evenly illuminates a space such as a classroom or office.

Often, clerestory windows also shine onto interior wall surface painted white or another light color. These walls are placed so as to reflect indirect light to interior areas where it is needed.

This method has the advantage of reducing the directionality to make it softer and more diffuse reducing shadows.



Figure 57: Clerestory window

5.3 Indoor artificial lighting

Artificial lighting sources such as lamps and fixture.

5.3.1 Fixture:

Lighting fixture come in a wide variety of styles for various functions. The most important function are as holder for the light source, to provide directed light and to avoid visual glare. Some are very plain and functional.



Figure 58: some type of fixture

5.3.2 Standards level of illumination

Table 7 recommended illumination in lux for offices

Task position or area	Optimum average illumination in lux	Notes
General offices	500	
Computer work stations	500	Local lighting may be required for reading a document
Drawing work stations	750	Local lighting is appropriate
Other areas, e.g. file storage and reception, telephone operators	300	

6.1 SHANGHAI TOWER



Figure 59: shanghai tower

Shanghai tower is a high rise building located at the middle of shanghai finance and trading zone, and it contains many sectors like offices, markets... etc. the side of our study of this case is the structural side, and how the building is established, also usage of curtain walls to serving the environmental design.

Shanghai tower will be one of the most advance high rise building in the world, the concept of the design is the transparency, second skin that warps the entire building. The ventilated halls are enclosed to conserve energy by modulating the temperature within the void. The space acts as an insulation between inside and outside, warming up the cool outside air in the winter and dissipating heat from the building interior in the summer. Mechanical equipment is spaced and located strategically throughout each zone of the building to provide optimal flexibility and efficiency.

The structural challenges in this building is windy climate, active earthquake zone, and clay-based soils typical of a river delta-, the structural engineers simplify the building structure. The heart of the structural system is concrete core, about 30 meters square as shown in figure 61.

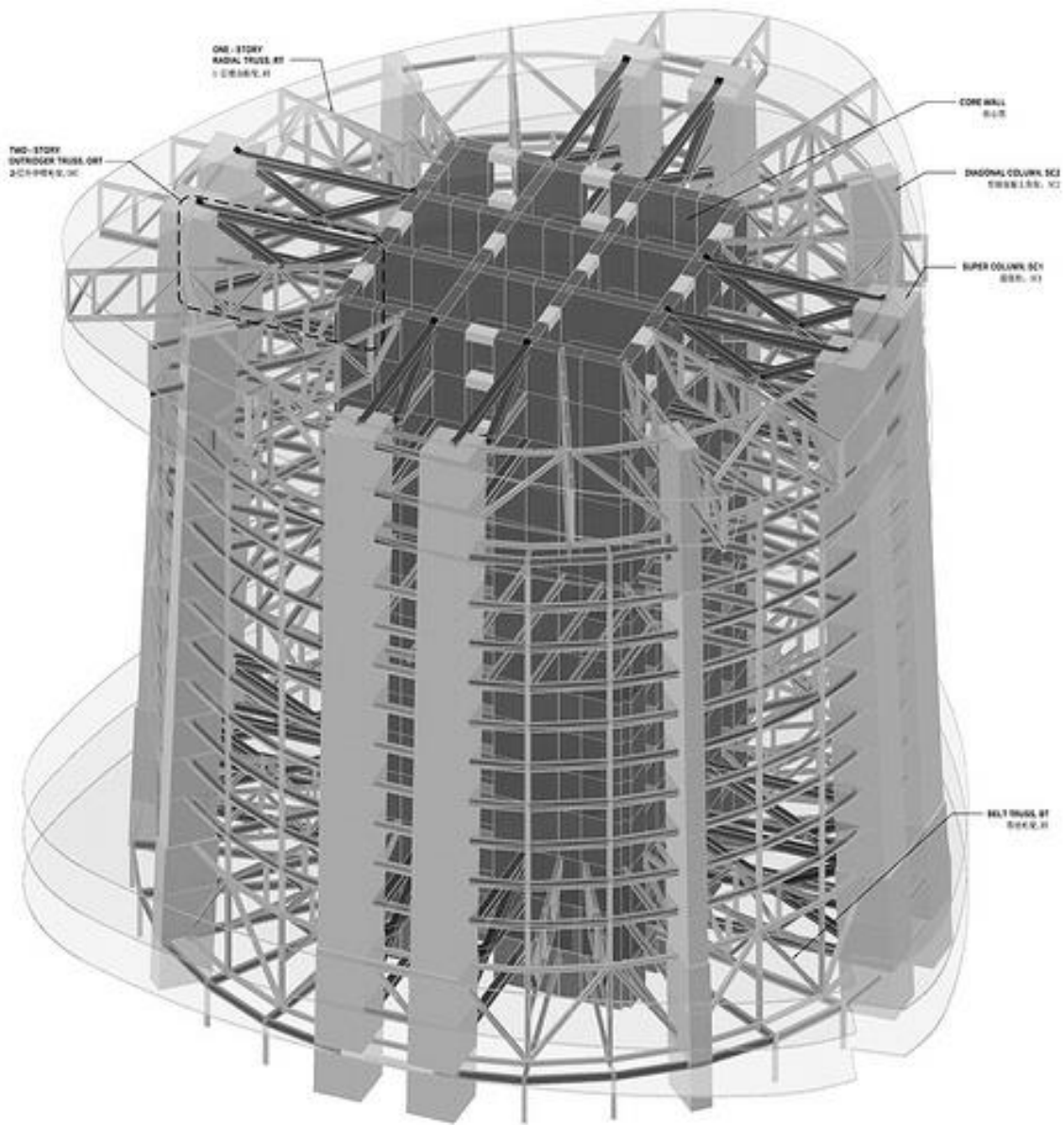

Figure 60: core profile and lateral system of shanghai tower

The core acts in concrete with an outrigger and main four paired diagonal super columns system two at each end of each orthonormal axis as shown in figure 61. In addition, four diagonal main columns along 45 degree axis are required by the long distance at the base between the main orthonormal super columns. These distances are approximately 50 meters and reduce to 25 meters to the diagonal columns.

The tower divided vertically into 9 zones, each zone have 12-15 floors, between the zones there are one or two floors for the mechanical, electrical and plumping equipment also, these two floors creates a base for the atrium spaces directly above.

The lateral and vertical resistance of the tower will be provided by the inner cylindrical tower. And the primary lateral resistance is provided by the core, outrigger, and super column system.

The core of the building is used as special zone for vertical transportation, and the elevators, stair cases, and emergency exits was focused on the strong side of the building which is the core.

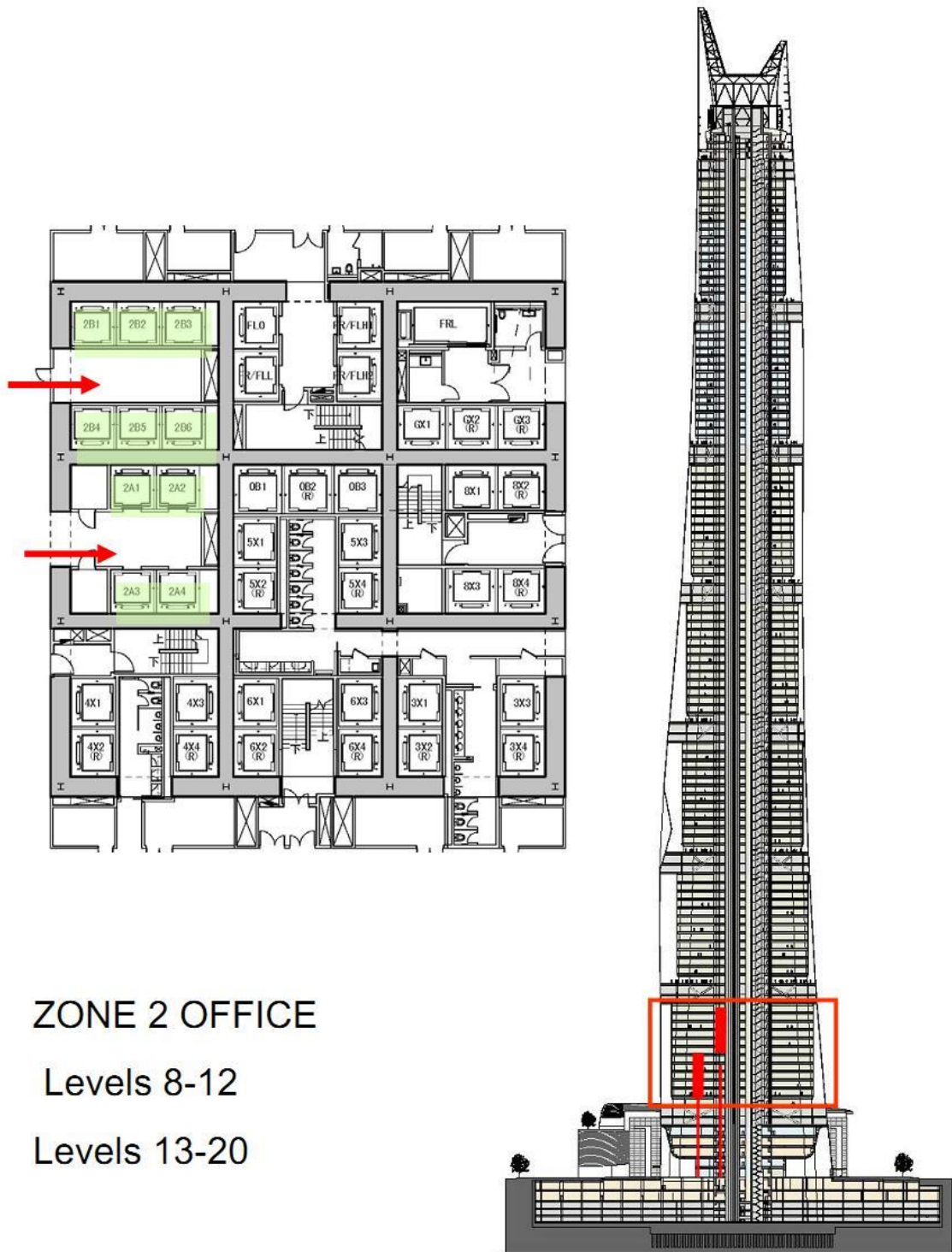

ZONE 2 OFFICE
 Levels 8-12
 Levels 13-20

MARSHALL STRABALA

上海中心大厦 SHANGHAI TOWER

Figure 61: office zone

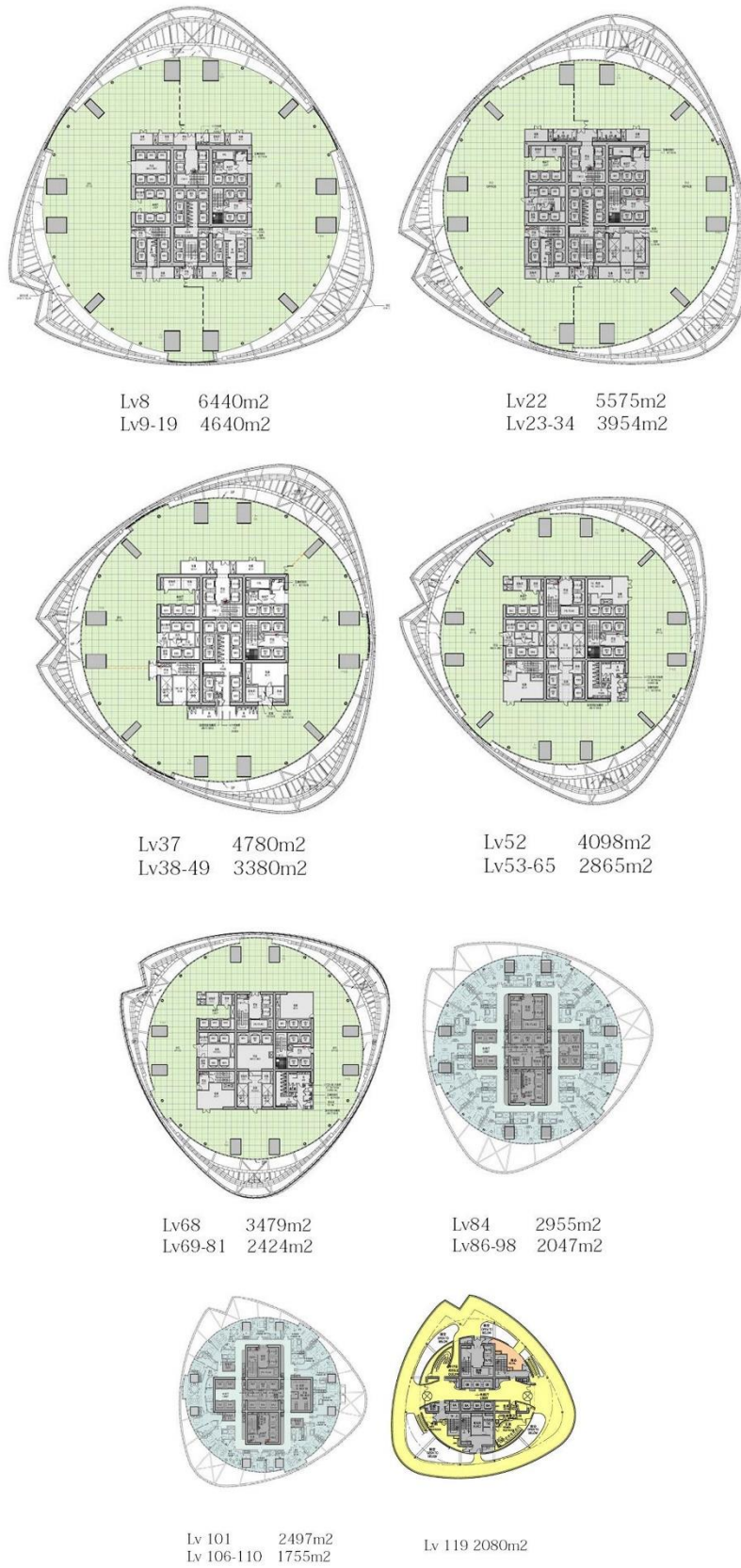

Figure 62: tower divided zones

6.1.1 Environmental side view

The functions in the building located around the core which means that the core is utilization for vertical transportation and don't need for daylight, this implies that the day light arrived to the whole located area around the core.

The curtain walls used for day light as two skins exterior and interior skin, also for heat gain in winter.

The tower has two independent curtain wall systems. The exterior skin is cam-shaped in plan, with rounded corners resembling a guitar pick, while the inner skin is circular. The spatial separation between two skins creates flowing atria every 12 to 15 floors within each the tower zones.

Both layers of the curtain walls will be transparent, and retail and event spaces will be provided at the tower's base. The transparent glass is a unique design feature, because most buildings have only a single facade using highly reflective glass to lower heat absorption, but the Shanghai Tower's double layer of glass will eliminate the need for either layer to be established.

The shape of inclined curved of the outer skin features laminated glass panels that filter the sun, wind and rain. The inner skin encloses the interior space with a conventional unitized low thermal emissivity coated insulating glass curtain wall system with integral operable solar control devices. This double skin wall system takes advantage of the stack effect to provide natural ventilation and cooling. The buffer areas between the inner and outer skins, helps to regulate the environment and collect and recycle rain water.



Figure 63: curtain wall system

6.2 MENARA MESINIAGA:

Menara Mesiniaga is the IBM headquarters in Subang Jaya near Kuala Lumpur. It is a high-tech, 15-storey corporate showcase on a convenient and visually prominent corner site. The singular appearance of this moderately tall tower is the result of architect Kenneth Yeang's ten-year research into bio-climatic principles for the design of medium-to-tall buildings. Its tripartite structure consists of a raised "green" base, ten circular floors of office space with terraced garden balconies and external louvers for shade, and is crowned by a spectacular sun-roof, arching across the top-floor pool. The distinctive columns that project above the pool floor will eventually support the installation of solar panels, further reducing the energy

consumption of a building cooled by natural ventilation, sun screens, and air conditioning. Yeang's ecologically and environmentally sound design strategies reduce long-term maintenance costs by lowering energy use. Importantly, designing with the climate in mind brings an aesthetic dimension to the project.

6.2.1 Environmental design strategies:

The noticeable building features of the IBM tower not only visually define the high-tech style of the company and its conceptual organic disposition, but also define it as a bioclimatic high-rise. First, the building's general form, structural strategy, component cores, glazed surfaces, is oriented for maximum environmental efficiency shading against direct overheating but allowing for natural daylight. Second, where the main components of the building and its orientation cannot shade the building, ingeniously calculated shading devices are installed on the building face for passive cooling. Finally, the extension of the land that begins at the sloped berm spirals up the height of the building with planted terraces that culminates at the inhabited rooftop. These terraces not only provide for vertical gardens and transitional spaces, but also shades and ventilates the building. These major innovations in form, envelope and regional adaptations to the typical skyscraper indicated that Yeang's work was at the leading edge of the then contemporary architecture at the time ecological design was at its organizational infancy. (Jones and David 1998)

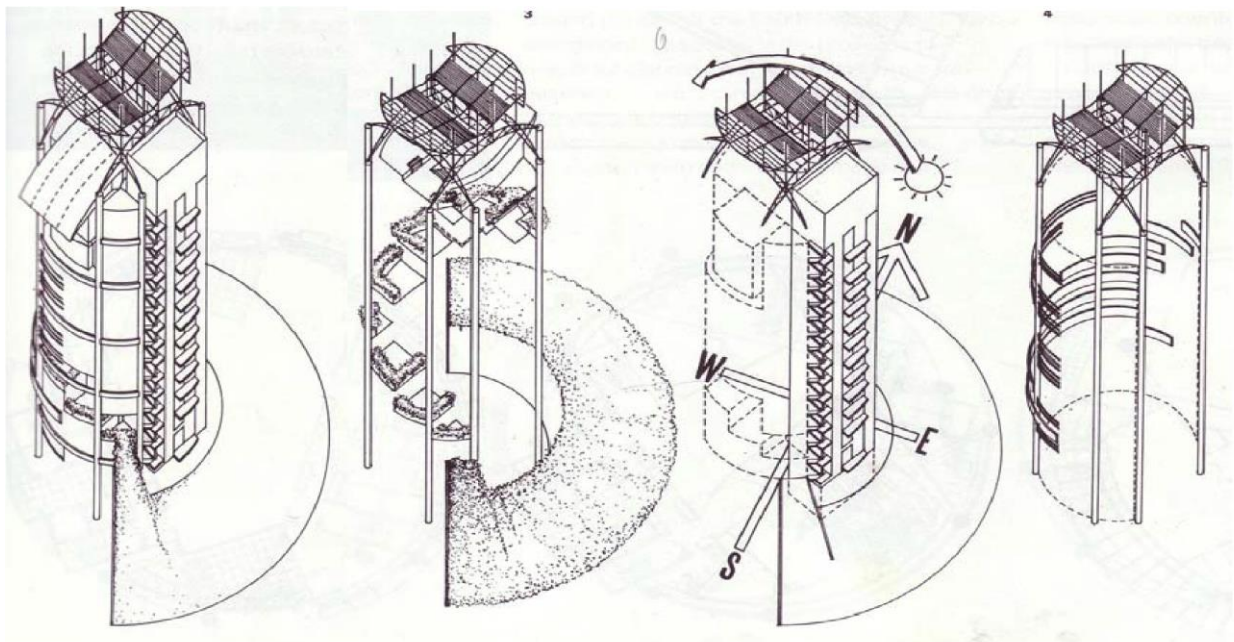

Figure 64: Axonometrics: (Left to Right) Built form; Planting & sky gardens; Solar orientation; Shading devices

6.2.2 Function and use

The building is equipped with 6-classrooms, a demo center, a 130-seat auditorium, lounge, cafeteria, and prayer rooms. The building boasts an excellent audiovisual system, complete lighting equipment, administrative and catering services and a large entry foyer for product

display and demonstration. It is wired for communications within itself and with its technology partners.

6.2.3 Technical data

Height - 63 meters: 14 floors (over ground) and only one floor under ground, the gross floor area – 6503 m sq., the building was completed in three years.

6.2.4 Site and climate:

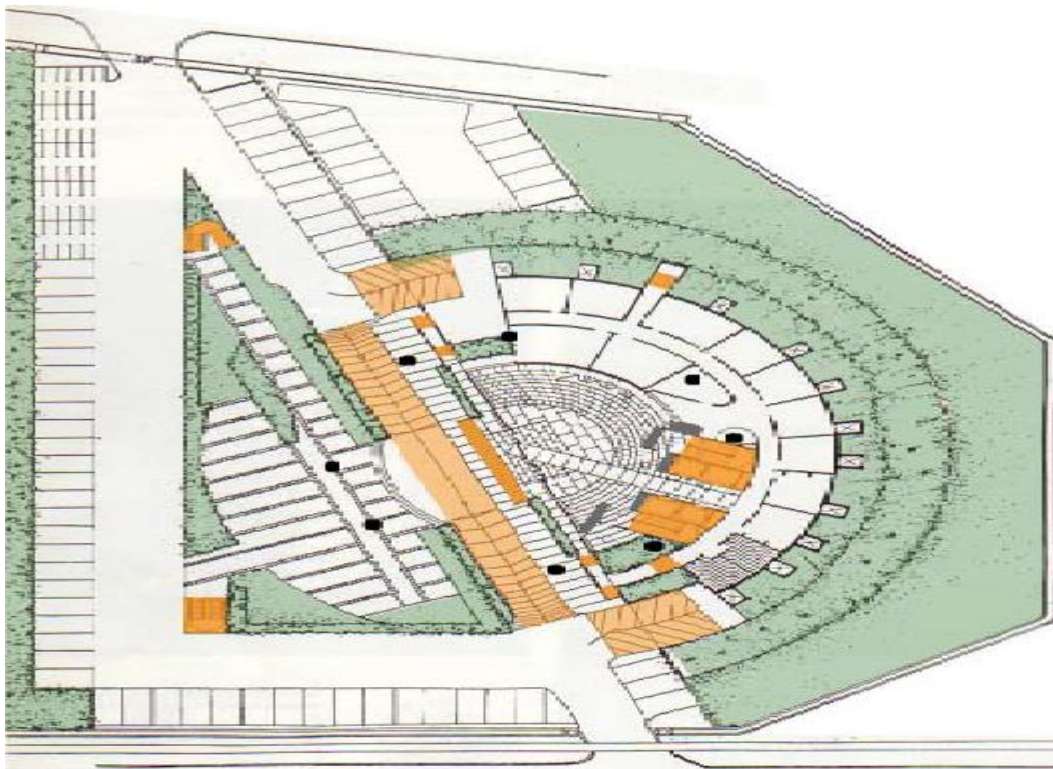

Figure 65: site of the project

The climate is considered tropical. The year round temperature, heat and humidity are fairly similar throughout the year. The day and night temperature very little. Artificial landscape was created to shelter and insulate the lowest three levels from the morning sun. Parking is located below the building and berm.

Menara Mesiniaga is located on a major highway from the airport to Kuala Lumpur. It is in a highly visible location with few buildings within the surrounding context.

6.2.5 Main ideas and concepts for the MENARA MESINIAGA:

- Sky gardens that serve as villages
- Shaded windows on the East and West
- Curtain wall glazing on the North and South
- Naturally ventilated and sunlit toilets, stair ways and lift lobbies
- Spiral balconies on the exterior walls with full height sliding doors to interior offices

The building is circular in plan. Yeang designed this building to include three items:

- 1- A sloping landscape base to connect the land with the verticality of the building.
- 2- A circular spiraling body with landscaped sky courts that allow visual relief for office workers as well as providing continuity of spaces connecting the land through the building.
- 3- The upper floor provides a swimming pool and gym.

The figures below show the function and use for Menara mesiniaga:

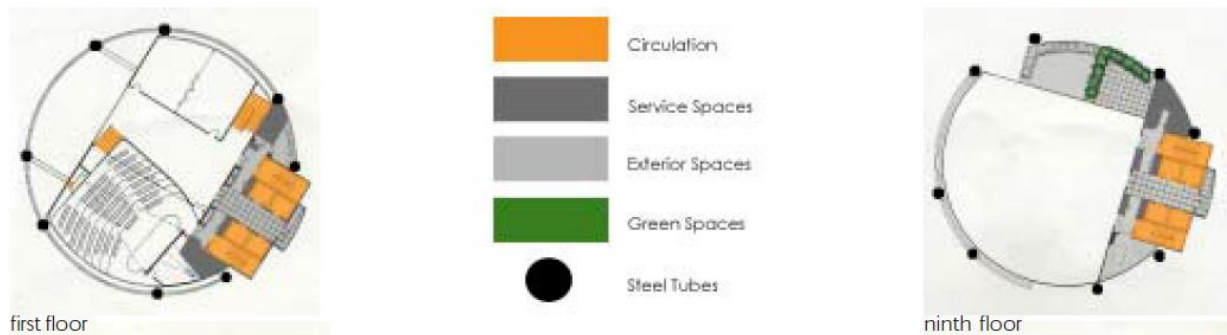

Figure 66: function and use for first and ninth floor

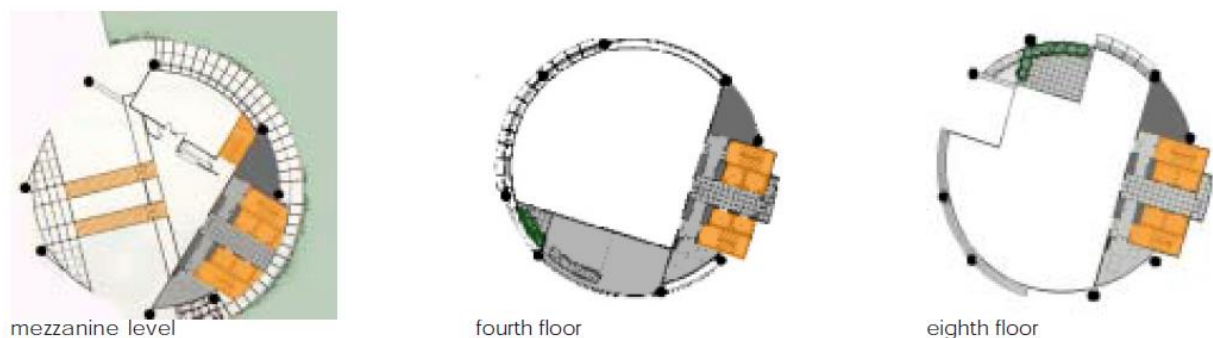
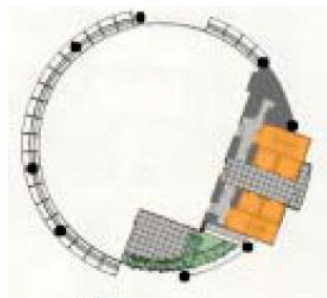
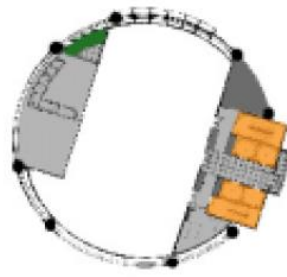

Figure 67: function and use for mid and fourth and eighth floor



second floor



seventh floor

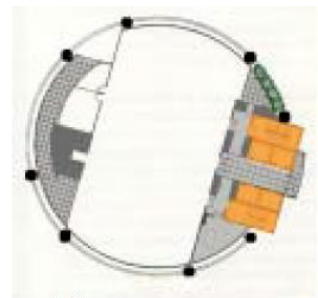

tenth floor

6.2.6 Shading devices:

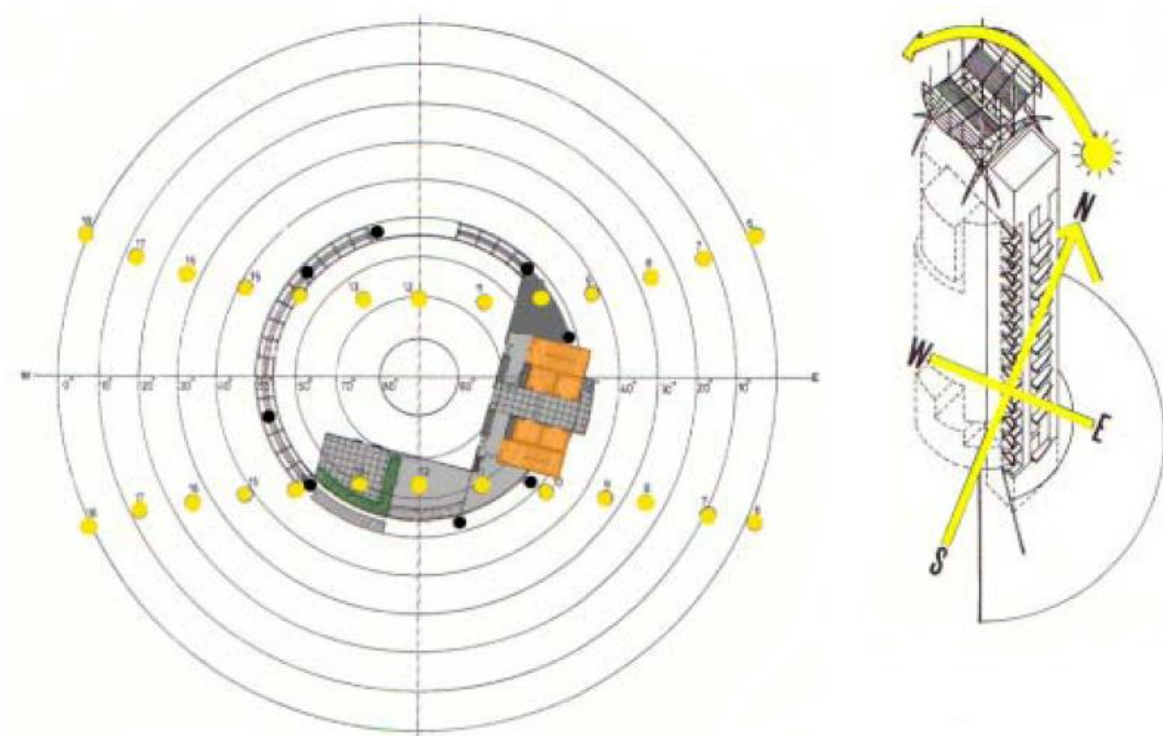

Figure 69: shading devices

The facade is a “sieve-like” filter (instead of a “sealed skin”). The louvers and shades relate to the orientation of the building. They allow or reduce solar gain. The deep garden insets allow full height curtain walls on the north and south sides- as a response to the tropical overhead sun path. The core functions are located on the “hot” side, the east.

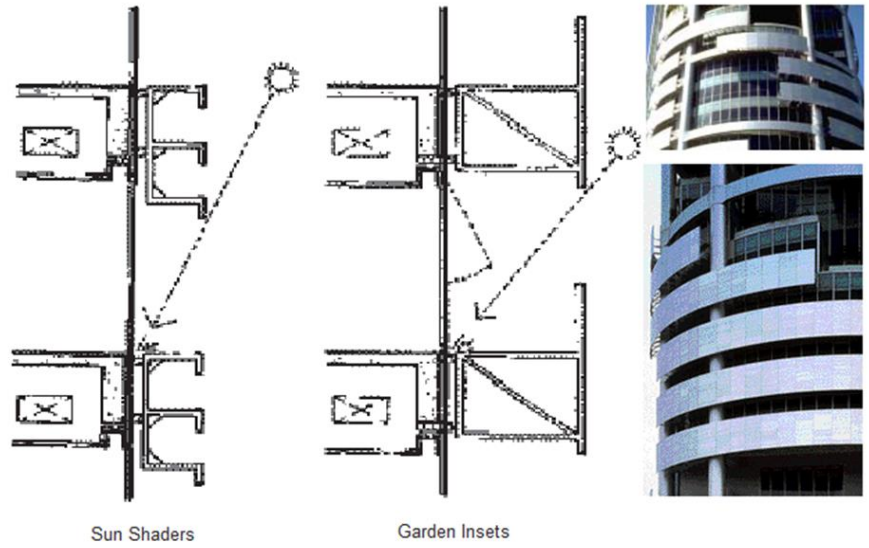

Figure 70: garden and sun shades



Left: Interior view of external solar shades on the west side

Middle: The spiralling stepped terraces allow fresh air through glass doors

Right: Close-up of west-facing shading devices

Figure 71: techniques for environmental design (Jones and David 1998)

6.2.7 Garden terraces:

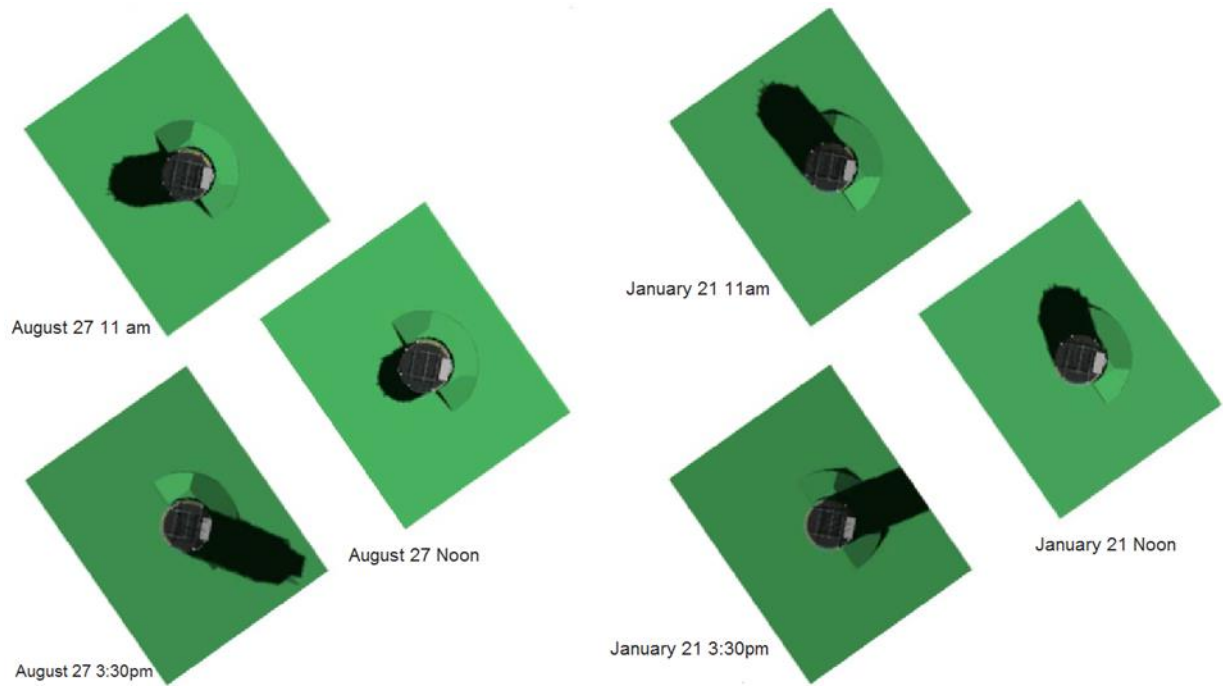

Figure 72: the shading effect due to garden terraces

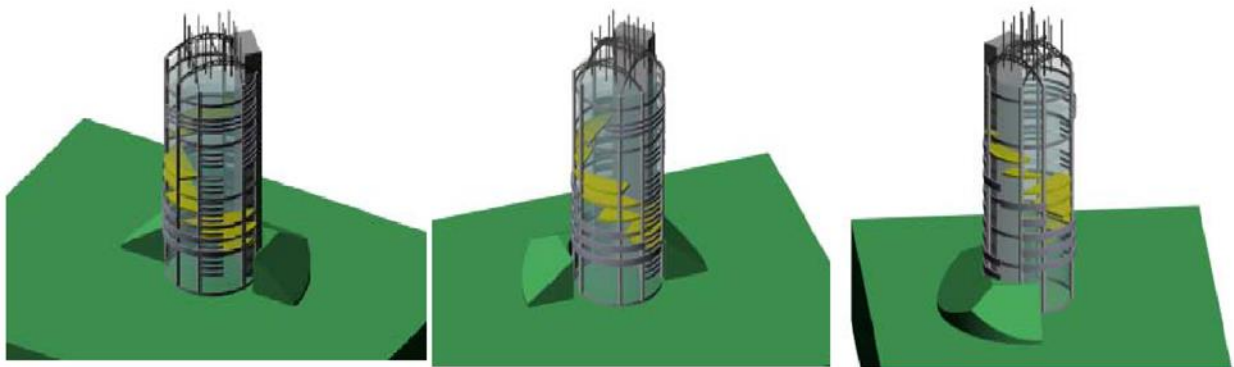

Figure 73: garden spiral, sun shades and sun screens

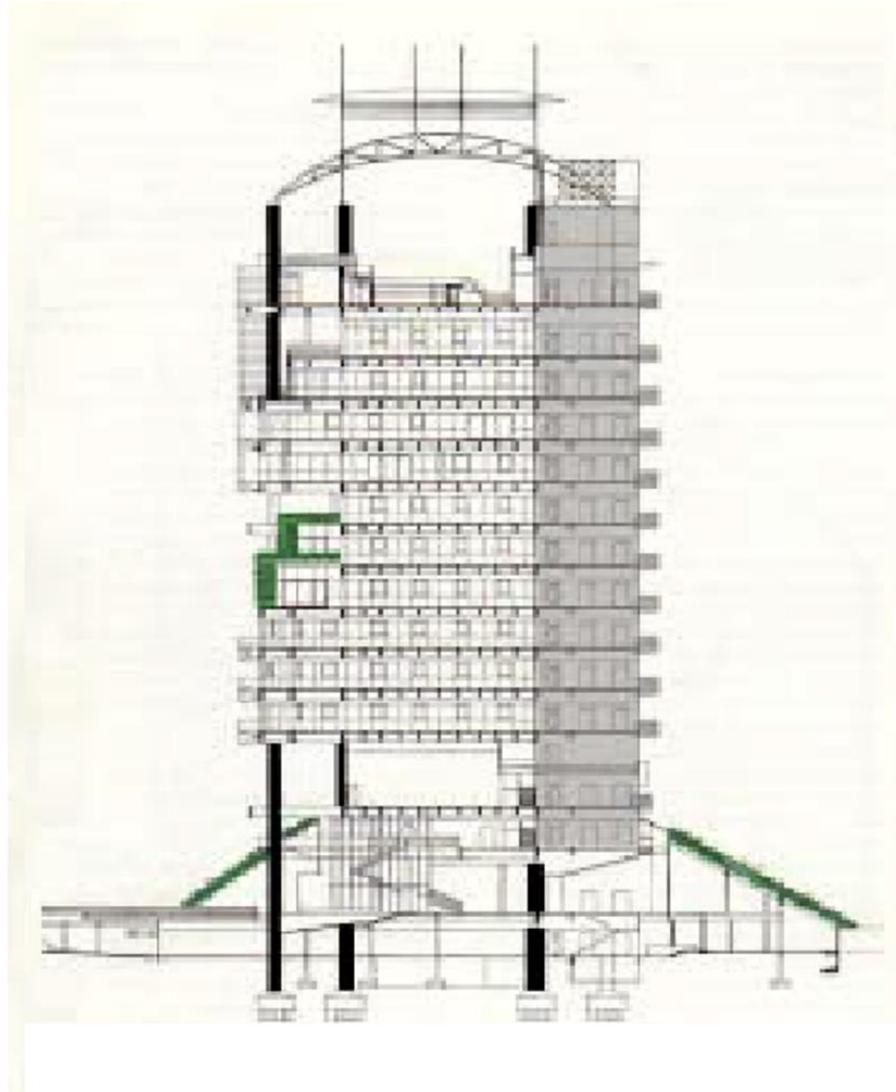

Figure 74: section shows land scape

Tall buildings are exposed to the full extent of heat, weather and temperatures. The overall building orientation has an important bearing on energy conservation. In the tropics, North and South faced opening reduce the need for insulation. Deep recesses may provide shade on the building's hot sides. Large multistory transitional spaces serve as in-between zones and allow air flow. External walls should be permeable with adjustable openings. Walls can provide solar and weather protection, as well as provide for cross ventilation. Plantings should travel vertically to generate oxygen and help cool the building. Passive solar shading is generally located on the east and west sides in the tropics. Cross ventilation should let fresh air into the buildings even in air conditioned spaces.

“The most powerful effects on the form of the building are from the sky-courts and the sun-shaded roof and its facilities, together with the separated cores that in their edge condition both shield the tower and are naturally ventilated.” (Jones and David 1998)

6.2.8 Structural aspects

The main structure of Menara Mesiniaga is exposed steel tubes. The floor plates are concrete over steel trusses. The core functions are located on the “hot” or east side. The elevator lobbies and lavatories which are not air conditioned and are on the east side to buffer the climate controlled offices from the sun. The main office spaces are naturally ventilated and air conditioned. The building is equipped with a Building Automated System which controls energy features including air conditioning and is utilized to reduce energy consumption in equipment. Other passive low energy features include: all windows on the east and west have aluminium louver to reduce solar gain; and the north and south windows have the deep insets acting as a thermal buffer. The shaft is alternately indented by garden terraces and fitted with brise-soleil on the east and west that saves \$13590 in air conditioning per year.

The roof is inhabitable. As part of Yeang’s fundamental idea of connecting the building back to land, the roof holds a pool and a gym. The roof acts as the capping social space of the building as well as an additional buffer between interior and exterior spaces. The sun screen structure is made of steel and holds aluminium panels. The structure is capable of holding solar panels (if ever installed). The scree shades the pool as well as the roof of the building. The rain water collection system is also on the roof. The roof is not problem free. Because of the high-humidity, the insulation has deteriorated and there has been some leakage. Elsewhere in the building some rusting has occurred. Yeang has since stressed an importance on material life-cycle costing. (Jones and David 1998)



Figure 75: Outdoor employee swimming pool

7.1 Project program

The project is to be an office building as we discussed before, thus, the program of execution the design of this project will depend on the areas and function used in the building. The previous collected data will help us to determine the required areas for the different functions that composing our building project.

Table 8: estimated area for administration

Administration			
function	number of persons	area for each person	net area
managers	1	40	40
deputy manager	2	35	70
secretary	2	15	30
employees	1	10	10
		net area	150

Table 9: estimated area for Human Resources Department

Human Resources Department			
function	number of persons	area for each person	net area
manager	1	35	35
deputy manager	2	20	40
secretary	2	15	30
employees	15	12	180
		net area	285

Table 10: estimated area for Legal Department and strategy

Legal Department			
function	number of persons	area for each person	net area
manager	1	35	35
deputy manager	2	20	40
secretary	3	15	45
employees	4	12	48
		net area	168
Strategy			
function	number of persons	area for each person	net area
manager	1	30	30
deputy manager	3	15	45
secretary	1	12	12
		net area	87

Table 11: estimated area for Finance department

Finance department			
function	number of persons	area for each person	net area
manager	1	30	30
deputy manager	1	15	15
secretary	1	12	12
accountant	10	12	120
employees	15	12	180
		net area	357

Table 12: estimated area for Sales

Sales			
function	number of persons	area for each person	net area
manager	1	30	30
deputy manager	1	15	15
secretary	2	12	24
employees	95	12	1140
		net area	1209

Table 13: estimated area for marketing

Marketing			
function	number of persons	area for each person	net area
manager	1	30	30
deputy manager	1	15	15
secretary	2	12	24
employees	33	12	396
		net area	465

Table 14: estimated area for information technology

information technology			
function	number of persons	area for each person	net area
manager	1	30	30
deputy manager	1	15	15
secretary	2	12	24
employees	25	12	300
		net area	369

Table 15: estimated area for technical

Technical			
function	number of persons	area for each person	net area
manager	1	30	30
deputy manager	1	15	15
secretary	2	12	24
employees	50	12	600
		net area	669

Table 16: estimated area for other public spaces

other public spaces			
function	number of persons	area for each person	net area
customer area	80	20	1600
exhibition			500
garage	150	37.5	5625
entrance hall	50	4	200
cafeteria	100	4	400
computers and network			500
		net area	8825

The total estimated area for the building is about 12584 m².

In addition of the areas mentioned above there is 10% to 20% added areas for circulation and services.

7.2 Site analysis

7.2.1 Location

Our project is located at Ramallah city which located at the northern of the west bank and it is built on a mountain that oversees the Palestinian coastline on the West side. On the East and South side it is surrounded by mountains. Ramallah is about 10 miles north of Jerusalem, and is about 16 km away from the sea seen from its mountains. The ships docked at sea are visible from Ramallah on occasions. Due to the proximity of the sea to it, the air coming to Ramallah from the West is humid, but the altitude of town from sea level which is about 830-880 meters makes this humidity less.

7.2.2 Climate in Ramallah

The climate in Ramallah is the Mediterranean climate. In winter, the town is subject to the harsh rainy south western winds and sometimes to the dry but cold north eastern winds.

The climatic characteristic for Ramallah city: air temperature, relative humidity, sun shine hours, rain fall and wind speed, we shown respectively in the next figures.

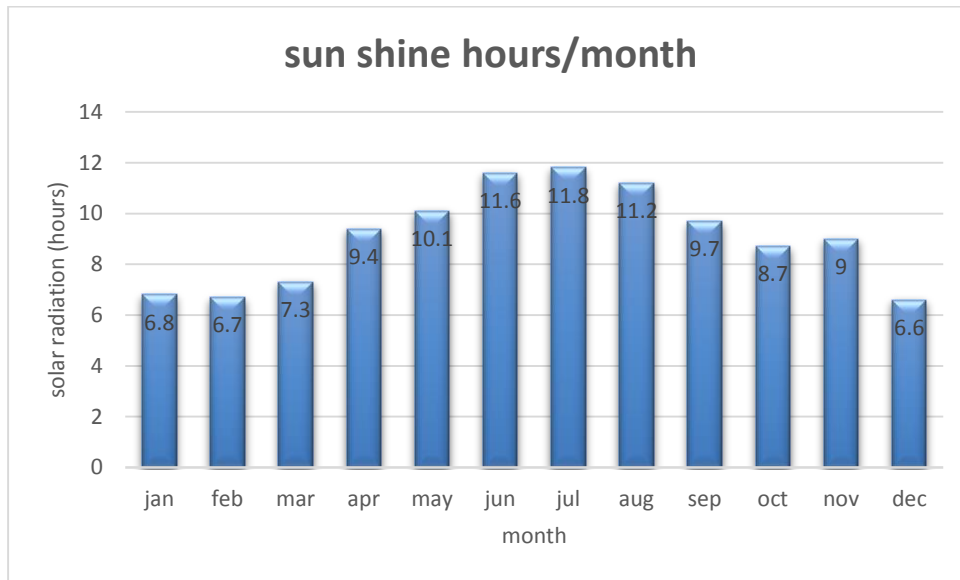

Figure 76: average solar radiation (PCB 2008)

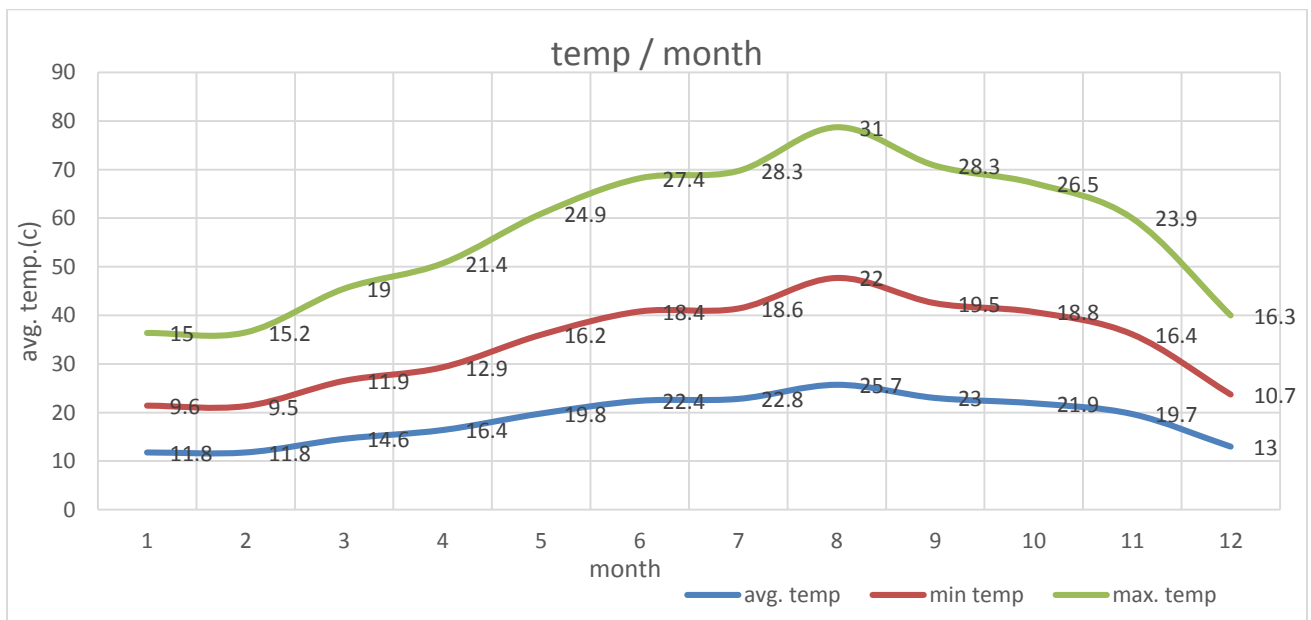

Figure 77: The maximum, average, and minimum temperatures (PCB 2008)

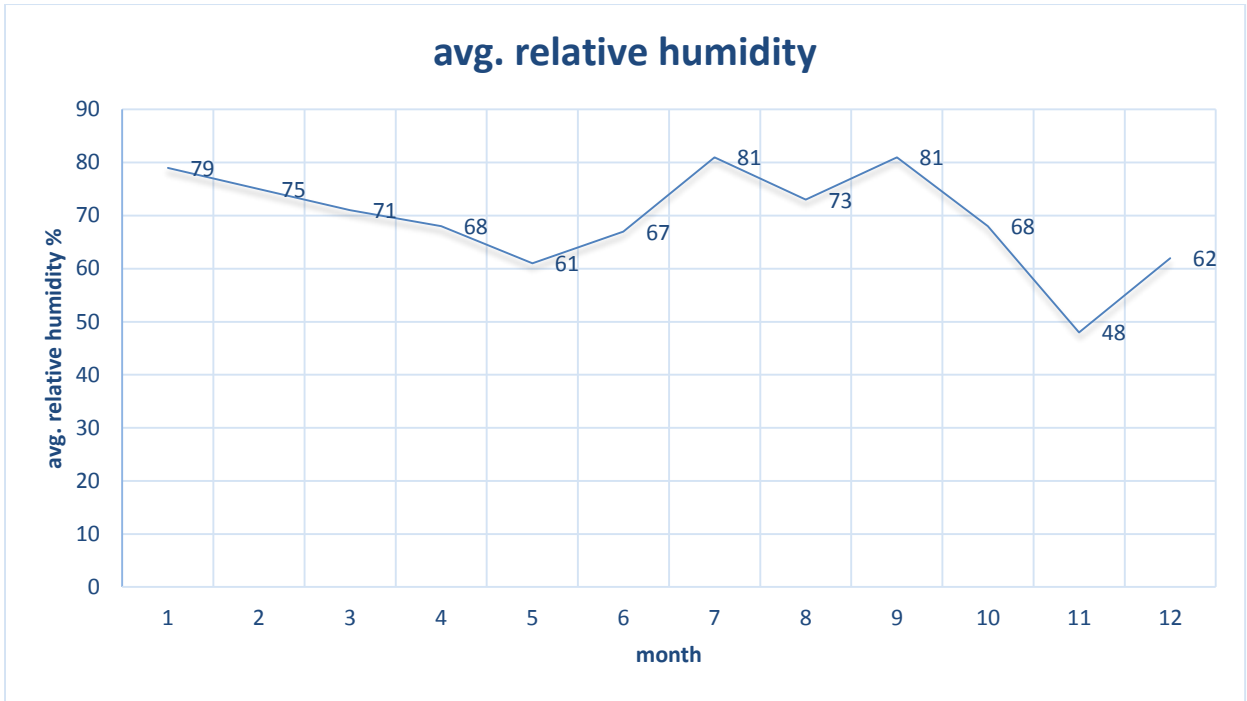

Figure 78: avg. relative humidity (PCB 2008)

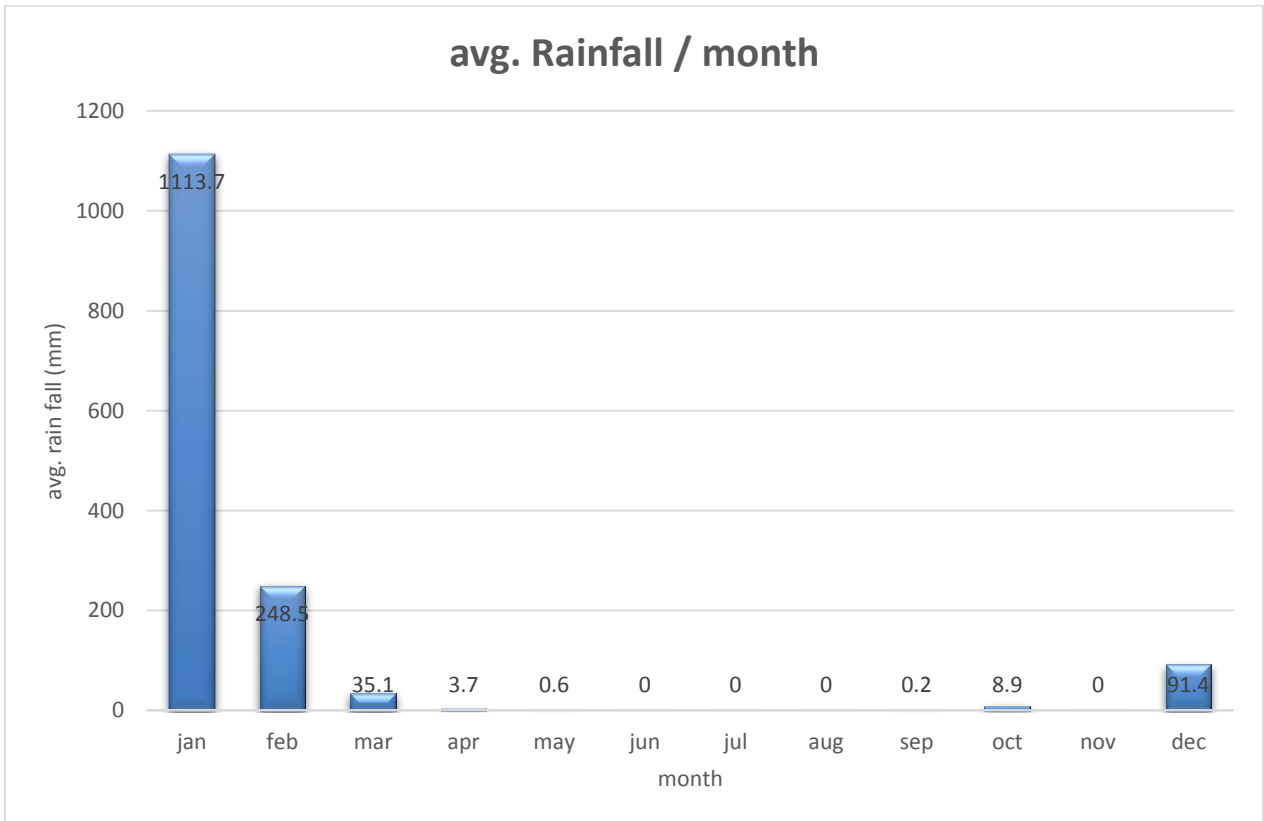

Figure 79: The average rain fall (PCB 2008)

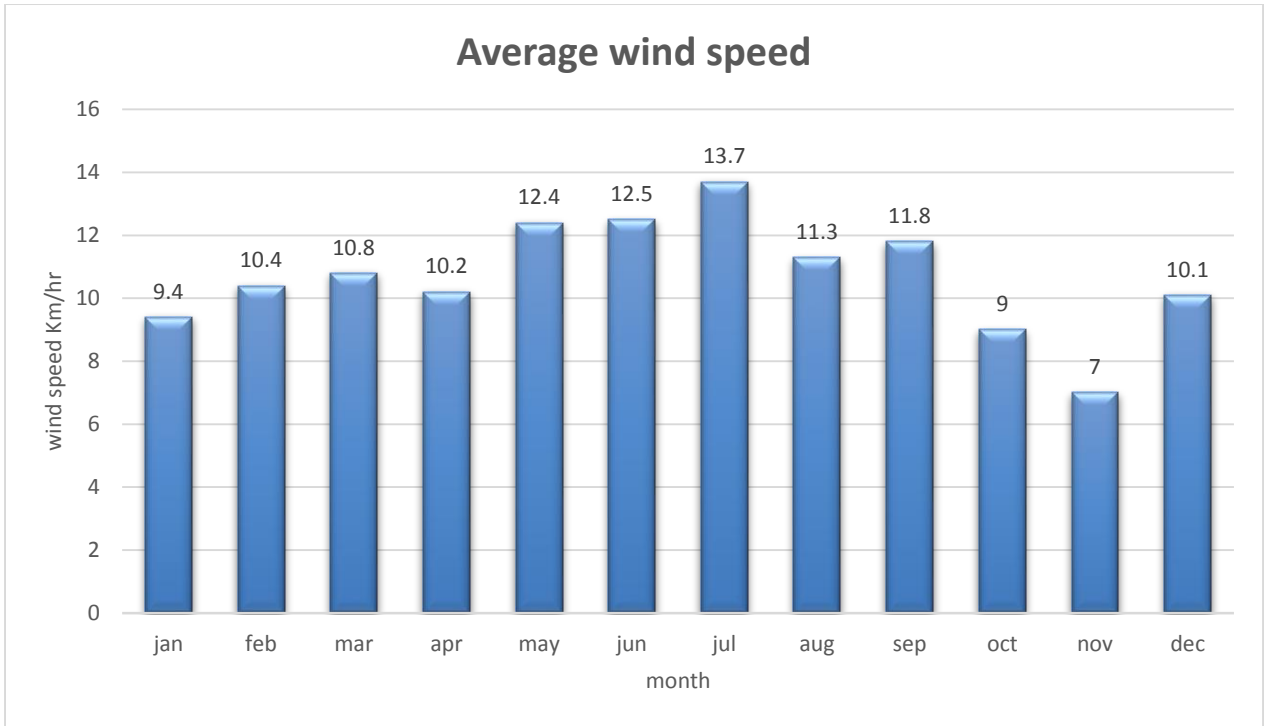

Figure 80: The average wind speed (PCB 2008)

In general, the climate in Ramallah is refreshing in the summer, and warm in winter which made life in it an active one.

7.2.3 Project Site

The project site is located in the northern of Ramallah and north- south of Al-Bira as shown in figure 78, and with area of 34184.3 m², thus there is an enough area for the building and parking.

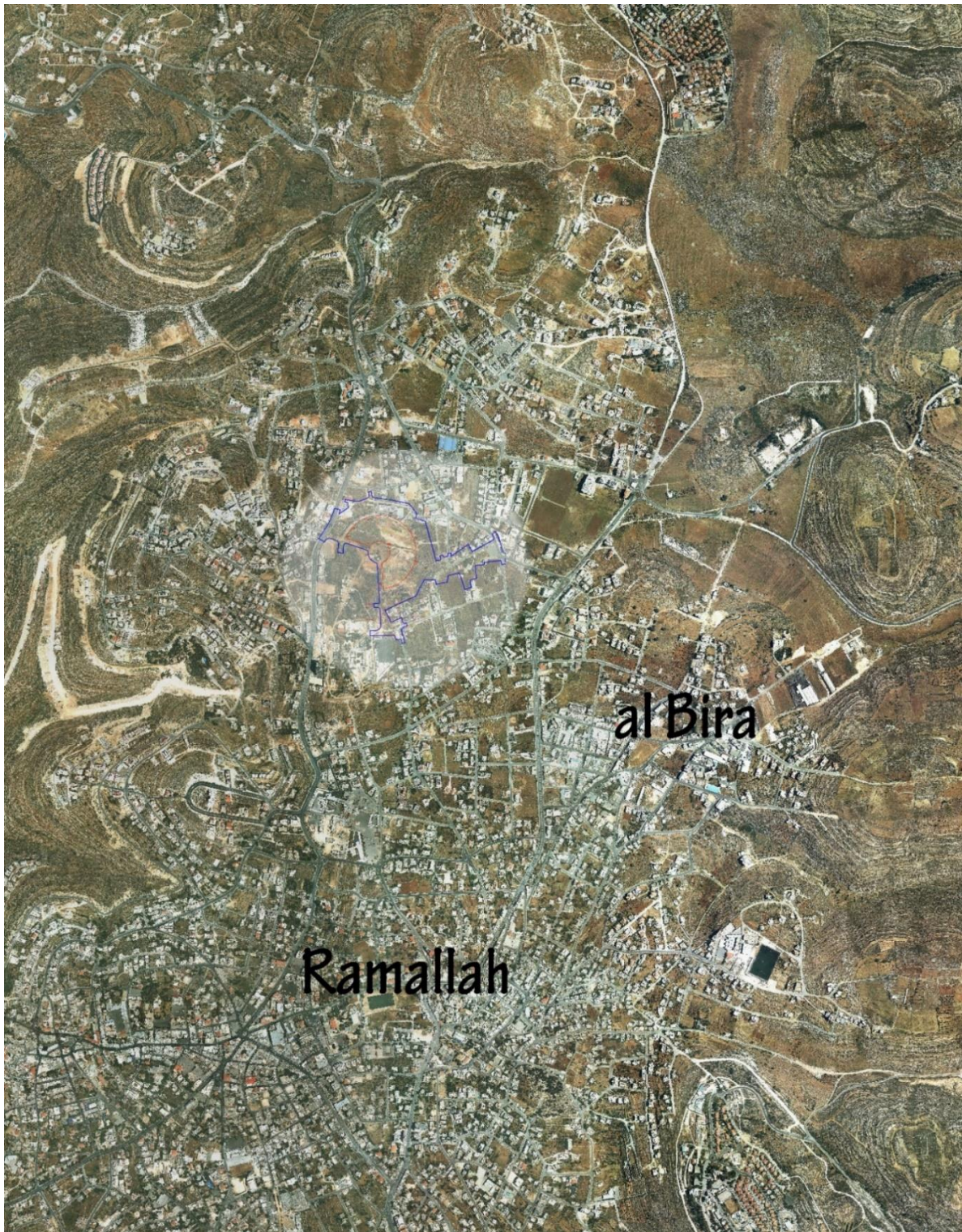

Figure 81: the project site relative to Ramallah city center

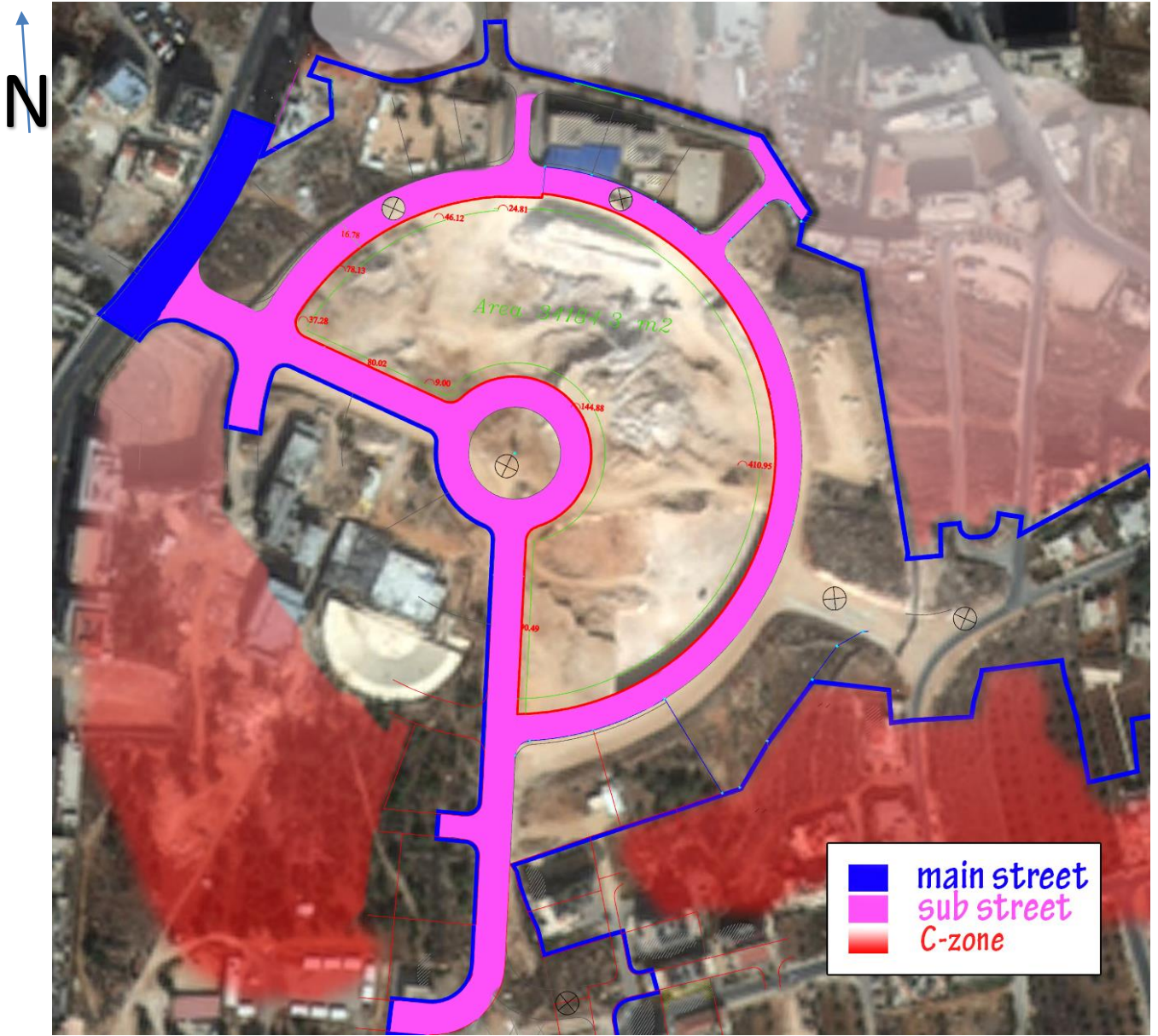

Figure 82: site plan - Aerial photograph

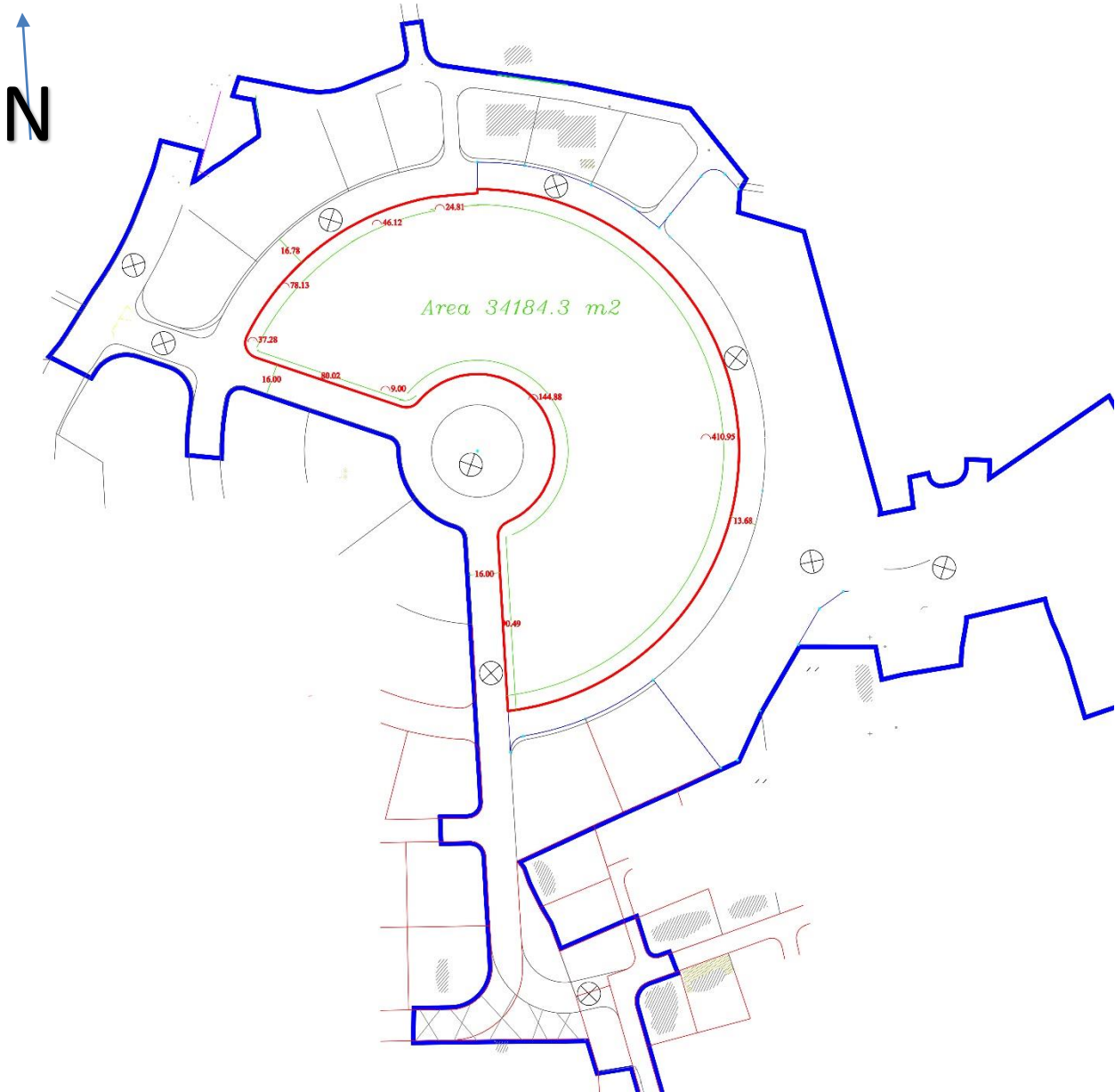

Figure 83: site plan and dimension

Figures 81 and 82 show the site and the surrounding building. As we see the site is open area and does not contain deference in leveling, in the north elevation there is one building and its height is 4 m (only one floor), and the surrounded is C-zone⁴.

The southern view is open for the sun and can be exploited for the environmental design, also the main street and sub streets is surround the site for our building so the entrance for the building and cars will be easy to establish.

⁴ C-zone is an area belonging to the (Israeli) government laws which mean that the surrounded buildings in the future will not exceed 4 floors.

BIBLIOGRAPHY

Grondzik, W, A Kwok , B Stein , and J Reynolds . 2010. *Mechanical and Electrical equipments for buildings*. Wiley.

Jones, and L David . 1998. *Architecture And The Environment: bioclimatic building design*. Overlook Press.

Michael, C, and W Donald. 2004. *Time-Saver Standards for Architectural Design: Technical Data for Professional Practice*. McGraw Hill Professional.

Neufert, and Ernst. 2012. *Architects' data*. John Wiley & Sons.

PCB. 2008. "The Palestinian Central Bureau Climate in the west bank."
http://www.pcbs.gov.ps/site/lang__ar/507/site/859/default.aspx. Accessed april 28, 2013.

2007. "strategies of architectural design and analysis." *ARCH 239*.